

Benutzeranleitung User manual Instructions d'utilisation



Elektronische Bedienungseinheit
für die Parametrierung automatischer Tür- und Torsysteme

Electronic control unit
to parameterise automatic entrance and door systems

Unité de commande électronique
pour paramétrer des systèmes de portes automatiques

BDE-D

D**INHALTSVERZEICHNIS**



- 1 KURZBESCHREIBUNG
- 2 TECHNISCHE DATEN
- 3 TEILEKENNZEICHNUNG
- 4 VERBINDUNG ZUR STEUERUNG
- 5 TASTENFUNKTIONEN
- 6 WICHTIGE HINWEISE PARAMETERMENÜ
- 7 BETRIEBSART WÄHLEN
- 8 FUNKTIONEN AUSFÜHREN
- 9 INFORMATIONEN AUSLESEN
- 10 STÖRUNGSANZEIGEN
- 11 BEDIENSPERRE
- 12 PARAMETER STEUERGERÄT (STG)
- BEISPIEL MIT SCHIEBEREGLER
- 13 STÖRUNGSBEHEBUNG



E**CONTENTS**



- 1 *BRIEF DESCRIPTION*
- 2 *TECHNICAL DATA*
- 3 *PARTS IDENTIFICATION*
- 4 *CONNECTION TO THE CONTROL UNIT*
- 5 *KEY FUNCTIONS*
- 6 *IMPORTANT NOTES, PARAMETER MENU*
- 7 *SELECTING MODE OF OPERATION*
- 8 *CARRYING OUT FUNCTIONS*
- 9 *READING OUT INFORMATION*
- 10 *FAULT INDICATIONS*
- 11 *CONTROL LOCK*
- 12 *CONTROL UNIT PARAMETERS (STG)*
- EXAMPLE WITH SLIDER CONTROL
- 13 *ERROR ELIMINATION*

F**TABLE DES MATIÈRES**

- 1 DESCRIPTION ABRÉGÉE
- 2 CARACTERISTIQUES TECHNIQUES
- 3 IDENTIFICATION
- 4 CONNEXION A L'UNITE DE COMMANDE
- 5 FONCTIONS DES TOUCHES
- 6 INSTRUCTIONS IMPORTANTES
- 7 SELECTIONNER MODE OPERATOIRE
- 8 EXECUTER FONCTIONS
- 9 LIRE DES INFOMATIONS
- 10 MESSAGES D'ERREUR
- 11 VERROUILLAGE DE COMMANDE
- 12 PARAMETRES UNITE DE COMMANDE
- EXEMPLE REGLAGE A CURSEUR
- 13 DEPANNAGE

D Symbole	
	Hinweis besonders nützliche Angaben hinsichtlich des Gebrauchs
	Vorsicht besondere Angaben, die für eine einwandfreie Funktion der Anlage unerlässlich sind
	Gefahr Angaben zur Verhütung von Personen- und Sachschäden
→ 14	Querverweis auf anderes Kapitel

E Symbols	
	Note <i>Particularly useful information concerning use</i>
	Caution <i>Special details that are indispensable for the satisfactory operation of the system</i>
	Danger <i>Information regarding the prevention of damage to persons and material</i>
→ 14	<i>Cross-reference to another chapter</i>

F Symboles	
	Instruction Des indications particulièrement utiles pour l'utilisation
	Attention Indications spéciales indispensables au bon fonctionnement du système
	Danger Indications pour éviter des accidents et des dégâts matériels
→ 14	Renvoi à un autre chapitre

1 KURZBESCHREIBUNG	
<p>Die elektronische Bedienungseinheit BDE-D ist eine komfortable Ein- und Ausgabeeinheit für die Bedienung und Programmierung von Steuergeräten in record Türantrieben.</p> <p>Logisch angeordnete Tasten erlauben eine intuitive Bedienung der Tür und Navigation durch die antriebsspezifische Menüstruktur. Das LCD-Display mit Hintergrundbeleuchtung vermittelt Angaben und Informationen zum Türzustand mittels Symbolen und Klartext. Es stehen mehrere Sprachen zur Auswahl, was einerseits die Benutzerfreundlichkeit erhöht und andererseits Interventionen im Service erleichtert.</p> <p>Die Verbindung zu den Steuergeräten erfolgt jeweils über den CAN-Bus.</p>	

1 BRIEF DESCRIPTION	
<p><i>The BDE-D electronic control unit is a convenient input and output unit for the control and programming of control units in record door openers.</i></p> <p><i>Logically arranged pushbuttons permit an intuitive operation of the door and navigation through the drive-specific menu structure. The LCD display with background lighting provides data and information regarding the status of the door by means of symbols and plain text messages.</i></p> <p><i>Several languages are available for selection, which increases the user friendliness on the one hand, and facilitates service interventions on the other.</i></p> <p><i>The connection to the controllers takes place via the CAN bus in each case.</i></p>	

1 DESCRIPTION ABRÉGÉE	
<p>L'unité de commande électronique BDE-D est une unité d'utilisation facile d'entrée et de sortie destinée à la commande et à la programmation des appareils de commande dans les entraînements.</p> <p>Des touches disposées logiquement permettent un maniement intuitif de la porte et de la navigation au moyen de la structure de menu spécifique à l'entraînement. L'afficheur LCD à rétroéclairage transmet des indications et informations relatives à l'état de la porte au moyen de symboles et en langage clair.</p> <p>Plusieurs langues sont disponibles au choix, ce qui d'une part augmente la convivialité et d'autre part facilite les interventions de service.</p> <p>La liaison avec les appareils de commande se fait chaque fois via le bus CAN.</p>	

2 TECHNISCHE DATEN	
Speisespannung:	24 VDC vom CAN-Bus
Anschlussleistung:	< 2 W
Dimension Frontplatte:	60 x 60 mm, einbaubar in Systeme von Feller oder Jung,
Dimension Einbauversion:	92 x 44 mm
Temperaturbereich:	-20...+50 °C
Auflösung LCD-Grafikdisplay:	112 x 64 Pixel, Hintergrundbeleuchtung

2 TECHNICAL DATA	
<i>Supply voltage:</i>	<i>24 VDC from CAN bus</i>
<i>Connected load:</i>	<i>< 2 W</i>
<i>Dimension of front panel:</i>	<i>60 x 60 mm, adapted for Feller or Jung systems</i>
<i>Dimension built-in type:</i>	<i>92 x 44 mm</i>
<i>Temperature range:</i>	<i>-20...+ 50 °C</i>
<i>Resolution of LCD display:</i>	<i>112 x 64 pixels, with background light</i>

2 CARACTERISTIQUES TECHNIQUES	
Tension d'alimentation:	24 VDC de bus CAN
Consommation:	< 2 W
Dimensions du plastron :	60 x 60 mm, adaptable pour systèmes de Feller ou Jung
Dimensions version à encastrer:	92 x 44 mm
Température:	-20...+50 °C
Résolution d'afficheur LCD:	112 x 64 pixels, avec éclairage de fond

3**TEILEKENNZEICHNUNG**

- 1 Folientastatur mit 6 Tasten
- 2 Navigationsangaben
- 3 LCD-Anzeige
- 4 Statusanzeigen (z.B. Kindersicherung, reduzierte Öffnung)
- 5 Betriebsart (Symbol und Text)
- 6 Menuüberschrift
- 7 Cursor, aktive Menuzeile
- 8 Navigationshilfe im Menu (Bildlaufleiste)
- 9 Menuzeilen (Verweis auf Untermenu)
- 10 Schieberegler
- 11 DIP-Schalter CAN-Abschluss / Umschaltung BDE 1 oder 2
- 12 Anschluss CAN-Bus
- 13 Anschluss für externe Bediensperre

3**IDENTIFICATION**

- 1 Keypad with 6 keys
- 2 Navigation information
- 3 LCD display
- 4 Status displays (e.g. child-proof lock, reduced opening width)
- 5 Operation mode (symbol and text)
- 6 Title of main menu
- 7 Cursor, active menu line
- 8 Navigation aid in the menu (scrollbar)
- 9 Menu lines (link to submenu)
- 10 Slider control
- 11 DIP-switch CAN-termination / selector BDE 1 or 2
- 12 Terminal board CAN bus
- 13 Terminal board for external service lock

3**IDENTIFICATION**

- 1 Clavier à effleurement avec six touches
- 2 Information de navigation
- 3 Affichage LCD
- 4 Etat (sécurité enfants, largeur d'ouverture réduite)
- 5 Mode opératoire (symbole et texte)
- 6 Titre du menu
- 7 Curseur, index du menu actif
- 8 Aide de navigation dans les menus (barre de déroulement)
- 9 Index du menu (renvoi au sous-menu)
- 10 Réglage à curseur
- 11 Interrupteurs DIP terminaison CAN / sélecteur BDE 1 ou 2
- 12 Connexion bus CAN
- 13 Connexion pour verrouillage de service externe

Frontansicht / Front view / Vue de face

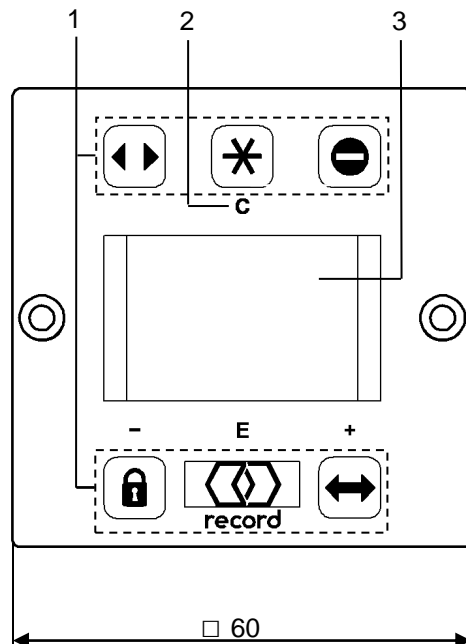

Anzeige / Display / Affichage

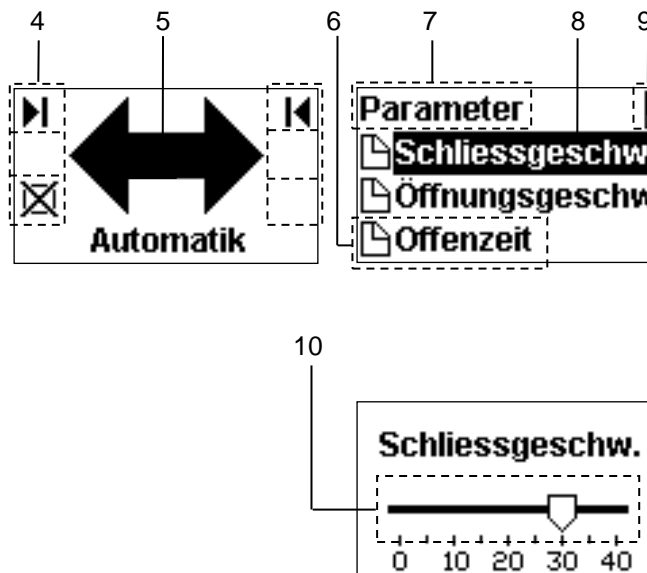

Rückansicht / Rear view / Vue arrière

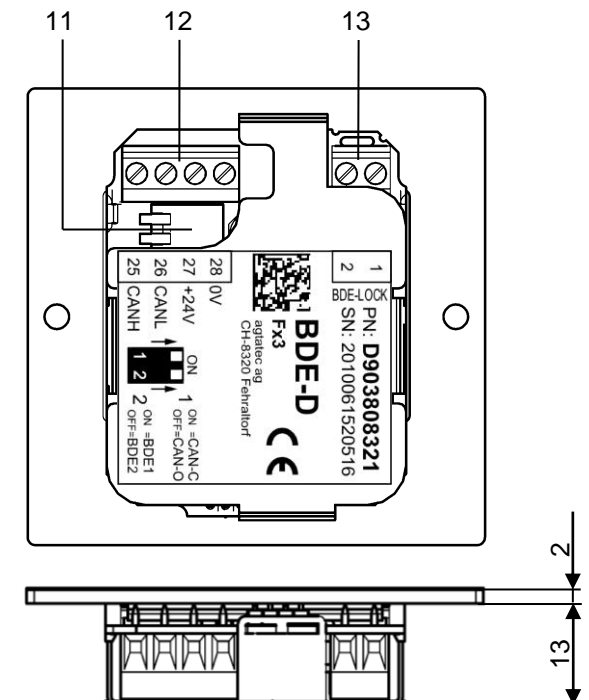

**EINBAUVERSION / BUILT-IN TYPE /
VERSION A ENCASTRER**

Frontansicht / Front view / Vue de face

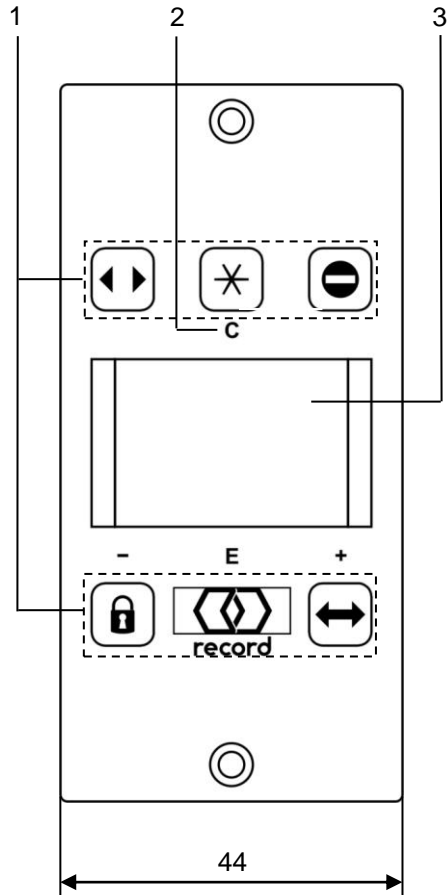

Rückansicht / Rear view / Vue arrière

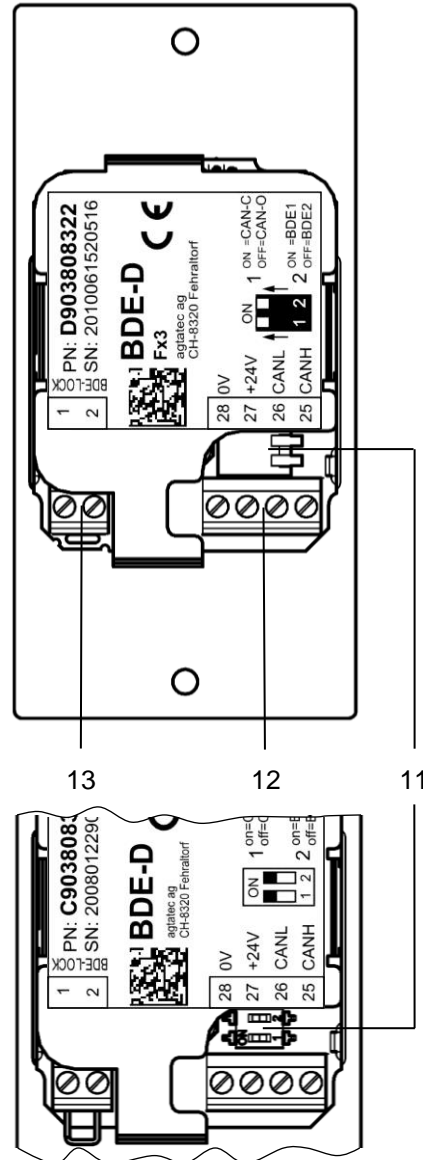

Seitenansicht / Side view / Vue de côté

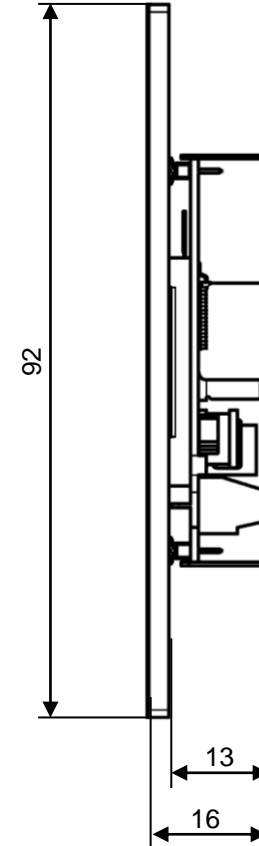

Anschluss an den CAN-Bus: 1)

Verbindungskabel am CAN-Anschluss (11) anschliessen und mit dem CAN-Anschluss der Steuerung verbinden (Adern paarweise verdreht).

Verbinden mit Steuerung...

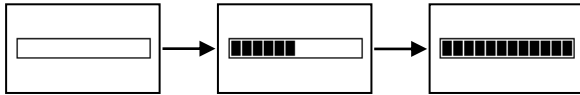

Die Verbindung wurde hergestellt (Beispiel)

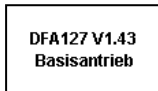

Keine Verbindung zur Steuerung

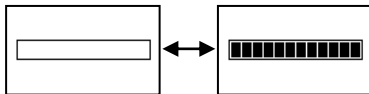
**Connection on CAN-bus: 1)**

Plug in the connecting cable to the CAN-port (11) and connect it to the CAN-port on the STG (twisted-pair cable).

Connect to the control unit ...

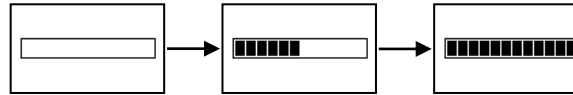

The control unit has been connected (example)

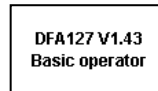

No connection to the control unit

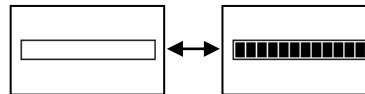
**Connexion au bus CAN: 1)**

Connecter le câble de raccordement au port CAN (11) puis au port CAN de la STG (conducteurs torsadés par paire).

Connecter avec unité de contrôle...

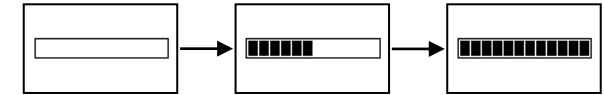

La connexion a été établie (exemple)

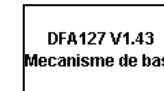

Aucune connexion établie avec la commande

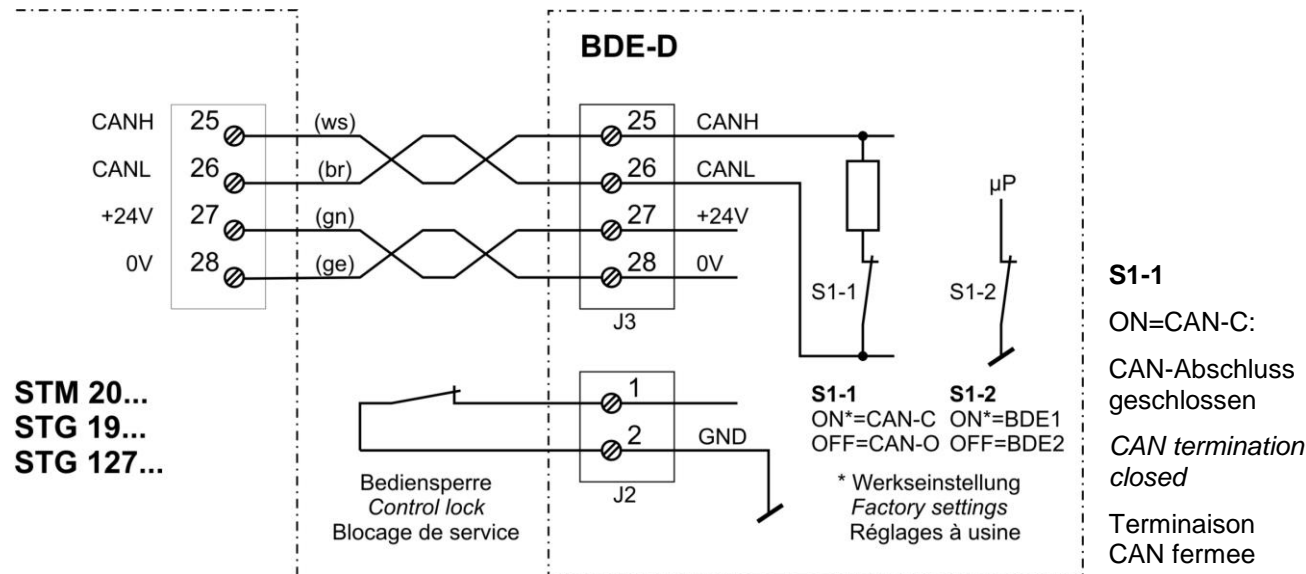
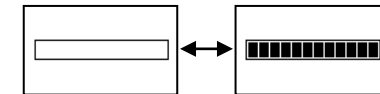

Drahtfarben:

Wire colours:

Couleur des fils:

ws = weiss/white/blanc

br = braun/brown/brun

































gn = grün/green/vert

ge = gelb/yellow/jaune

1) DIP-Schalter (S1-1, S1-2) müssen vor dem Anschliessen eingestellt werden!

Set the DIP-switches (S1-1, S1-2) before connecting to the CAN-port!

Les commutateurs DIP (S1-1, S1-2) doivent être réglés avant connexion avec le port CAN!

5 TASTENFUNKTIONEN	5 KEY FUNCTIONS	5 FONCTIONS DES TOUCHES
 Automatik-Betrieb	 <i>Automatic operation</i>	 Service automatique
 Daueroffen-Betrieb	 <i>Hold-open operation</i>	 Service ouvert en permanence
 Einbahn-Betrieb	 <i>One-way operation</i>	 Service à sens unique
 Verriegelt	 <i>Locked</i>	 Verrouillé
 STA: reduzierte Öffnungsweite DFA: Handbetrieb	 <i>STA: reduced opening width DFA: manual operation</i>	 STA : largeur d'ouverture réduite DFA : mode manuelle
 <ul style="list-style-type: none"> - Anzeige von Zusatzinformationen - Zugriff auf Parameter-Menü - Einleiten der Bediensperre - Neustart STG > 5 s drücken - Neustart Hardware BDE-D > 12 s drücken 	 <ul style="list-style-type: none"> - <i>Display for additional information</i> - <i>Access to parameter menu</i> - <i>Start procedure for service lock</i> - <i>Restart STG: press > 5 s</i> - <i>Restart BDE-D hardware: press > 12 s</i> 	 <ul style="list-style-type: none"> - Affichage des informations complémentaires - Accès aux menus paramètres - Démarrage procédure du blocage de service - Redémarrage STG : presser > 5 s - Redémarr. matériel BDE-D : presser > 12 s
 Menüpunkt auswählen, Eingabe bestätigen	 <i>Select the menu item, and confirm entry</i>	 Sélectionner une ligne du menu, valider
 <ul style="list-style-type: none"> - Bewegungsrichtung nach unten bei der Auswahl der Menüpunkte - Schieberegler nach rechts für Wert erhöhen 	 <ul style="list-style-type: none"> - <i>Move down to select menu item</i> - <i>Slider control to the right to increase the value</i> 	 <ul style="list-style-type: none"> - Touche curseur vers le bas pour sélectionner et naviguer dans le menu - Réglage curseur à droite pour augmenter la valeur
 <ul style="list-style-type: none"> - Bewegungsrichtung nach oben bei der Auswahl der Menüpunkte - Schieberegler nach links für Wert vermindern 	 <ul style="list-style-type: none"> - <i>Move up to select menu item</i> - <i>Slider control to the left to decrease the value</i> 	 <ul style="list-style-type: none"> - Touche curseur vers le haut pour sélectionner et naviguer dans le menu - Réglage curseur à gauche pour diminuer la valeur
 Menüpunkt verlassen, abrechnen (ohne zu speichern)	 <i>Leave menu item, escape (without saving)</i>	 Quitter menu, échapper (sans enregistrer)
 Automatische Rückkehr zur Hauptansicht 3 Min. nach letzter Eingabe	 <i>Automatic return to the standard screen 3 minutes after last input</i>	 Auto-retour à l'écran principal 3 min. après la dernière entrée

6

WICHTIGE HINWEISE



Das unsachgemäße Verändern der Einstellungen kann die einwandfreie und sichere Funktion der Anlage beeinträchtigen!



Zugriff auf die Parameter

- Endkunde oder Betreiber der Anlage

Tastenfolge:



Parameter oder Daten, die im Steuergerät nicht oder als unbekannte Werte vorhanden sind, enthalten ein Fragezeichen und können je nach Typ unterschiedlich dargestellt werden.

MIT SCHIEBEREGLER

Schliessgeschw.

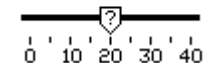

6

IMPORTANT NOTES



Inappropriate modification of the settings could impair the correct and safe function of the installation!



Access to the parameters

- End customer or operator of the installation

Key sequence:



Parameters or data that are not present in the control unit or are only present as unknown values will be indicated by a question mark and can be displayed in different ways depending on their type.

WITH SLIDER CONTROL

Closing speed

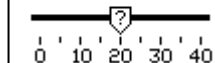

6

INSTRUCTIONS IMPORTANTES



La modification inappropriée des réglages peut altérer le bon fonctionnement de l'installation !



Accès aux paramètres

- Client final ou exploitant de l'installation

Séquence de touches:



Les paramètres ou données, qui n'existent pas ou existent comme valeurs inconnues dans l'appareil de commande, comprennent un point d'interrogation et peuvent être affichés différemment en fonction du type.

AVEC REGLAGE A CURSEUR

Vitesse fermet.

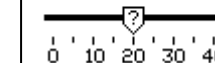

7

BETRIEBSART WÄHLEN

STA SCHIEBETÜRANTRIEB

Betriebsart Anzeigesymbol



Automatik



Automatik



Daueroffen



Daueroffen



Einbahn



Einbahn



Handbetrieb



Handbetrieb

Oder Drücken 2 s



Verriegelt

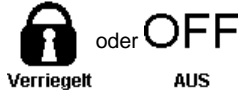

Verriegelt

AUS

reduzierte
Öffnungsweite

Automatik

DFA DREHFLÜGELTÜRANTRIEB

Betriebsart Anzeigesymbol



Automatik



Automatik



Daueroffen



Daueroffen



Einbahn



Einbahn



Verriegelt

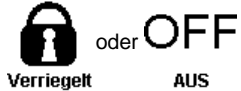

Verriegelt

AUS



Handbetrieb



Handbetrieb

7

SELECT THE MODE OF OPERATION

STA SLIDING DOOR

Operation mode Display



Automatic



Automatic



Hold open



Cont. open



One-way



One-way



Manual



Manual

Or press 2 s



Locked

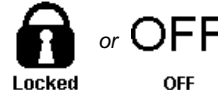

Locked

OFF

reduced opening
width

Automatic

DFA SWING DOOR

Operation mode Display



Automatic



Automatic



Hold open



Cont. open



One-way



One-way



Locked

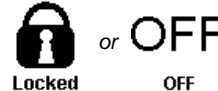

Locked

OFF

Manual
operation

Manual

7

SELECTIONNER MODE OPERATOIRE

STA PORTE COULISSANTE

Mode opératoire Affichage



Automatique



Automatique

Ouvert en
permanence

Ouv. permanence



Sens unique



Sens unique



Manuel



Cmd. manuelle

Ou presser 2 s



Verrouillée



Verrouille

ARRET

largeur d'ouver-
ture réduite

Automatique

DFA PORTE BATTANTE

Mode opératoire Affichage



Automatique



Automatique

Ouvert en
permanence

Ouv. permanence



Sens unique



Sens unique



Verrouillée



Verrouille

ARRET



Mode manuel



Cmd. manuelle

8**FUNKTIONEN AUSFUEHREN****NEUSTART DER STEUERUNG****Drücken > 5 s**

Nein

Nein
Reset Steuerung?
Ja



Ja

NEUSTART HARDWARE BDE-D**Drücken > 12 s**

Verbinden mit Steuerung...

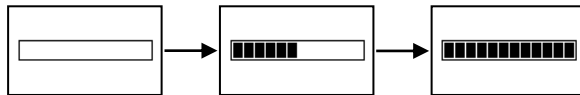

Die Verbindung wurde hergestellt (Beispiel)

DFA127 V1.43
Basisantrieb**8****CARRYING OUT FUNCTIONS****RESTARTING THE CONTROL UNIT****Press > 5 s**

No

No
Reset control?
Yes



Yes

RESTART BDE-D HARDWARE**Press > 12 s**

Connect to the control unit...

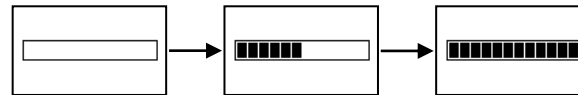

The control unit has been connected (example)

DFA127 V1.43
Basic operator**8****EXECUTER FONCTIONS****REDÉMARRAGE UNITE DE CDE.****Presser > 5 s**

Non

Non
Reset commande?
Oui



Oui

REDÉMARRAGE MATERIEL BDE-D**Presser > 12 s**

Connecter à l'unité de contrôle...

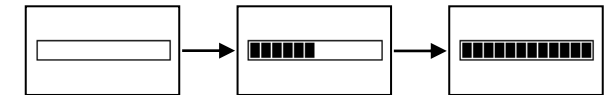

La connexion a été établie (exemple)

DFA127 V1.43
Mecanisme de base

ÖFFNUNG MIT SSK



Nur in Betriebsart **Verriegelt**.



Betriebsart **Verriegelt** wählen



Für die Auslösung mit SSK die Taste **Verriegelt** erneut drücken

ÖFFNUNGSPULS BEIM EDITIEREN



Während dem Anpassen von Parametern und Konfigurationen kann die Auswirkung direkt überprüft werden.



Für die Auslösung eines Öffnungspulses die Taste **Daueroffen** drücken

OPENING WITH SSK



Only in operation mode **Locked**.



Select operation mode **Locked**



Press key **Locked** again to release SSK

OPENING WHILE EDITING



Check directly the effect when parameters and configurations have been edited.



Press key **Hold open** to release an opening

OUVERTURE AVEC SSK



Seulement en mode opératoire **Verrouillée**.



Choisir mode opératoire **Verrouillée**



Pousser la touche **Verrouillée** encore une fois pour déclencher SSK

IMPULSION D'OUVERTURE PENDANT LA MODIFICATION



Vérifiez directement l'effet quand les paramètres et des configurations ont été édités.



Pousser la touche **Ouvert en permanence** pour déclencher une ouverture

SYSTEMINFORMATIONEN



Informationen über das Antriebssystem, wie z.B. die Softwareversion, können in der Hauptansicht ausgelesen werden.

E



Drücken ca. 2 s

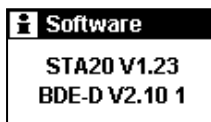

Blättern in den Informationen

E

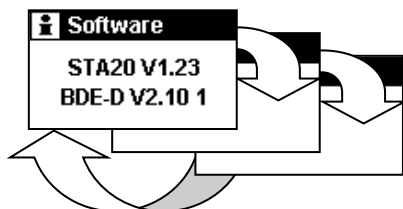

E



E

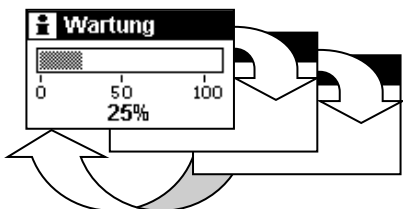

Rückkehr zur Hauptansicht mit Tastendruck oder automatisch nach 20 s.

SYSTEM INFORMATION



Information about the drive system, such as the software version, can be read out from the Standard screen.

E



Press approx. 2 s

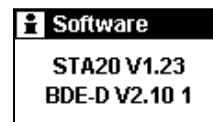

Browsing through information screens

E

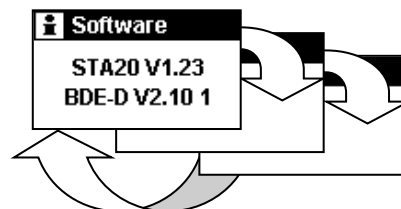

E

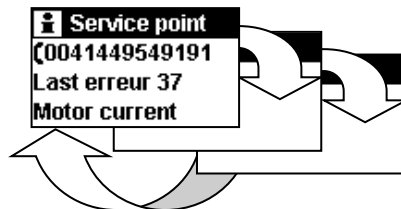

E

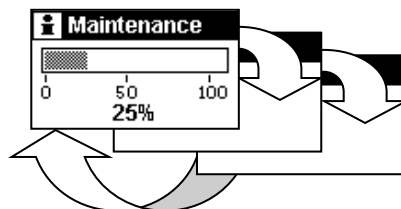

Return to the Standard screen by key press or automatically after 20 s.

INFORMATIONS DU SYSTÈME



L'écran principal permet de consulter des informations sur le système d'entraînement, telles que par ex. la version du logiciel.

E



Presser environ 2 s

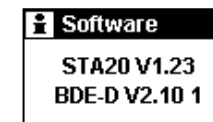

Naviguer dans les informations

E

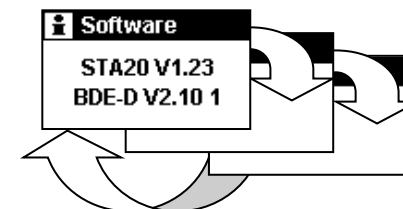

E

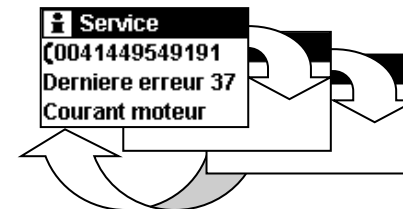

E

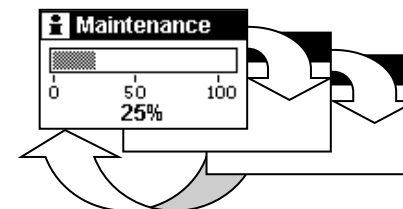

Retour manuel à l'écran principal en appuyant sur une touche ou automatiquement au bout de 20 s.

Aktuelle Betriebsstörungen des Antriebssystems werden in der Hauptansicht angezeigt.

Nach 2 s wechselt die Anzeige zwischen normal / invers

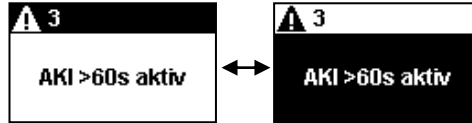

Sind mehrere Störungen aktiv, so werden sie nummeriert:
z.B. Fehler 1/2

E



Temporäre Rückkehr in die Hauptansicht für 4 s.

MASTER/SLAVE INSTALLATIONEN

Zwischen der aktuellen Störung des Master- und Slave-Antriebs kann gewechselt werden.

Blättern in den Störungsanzeigen

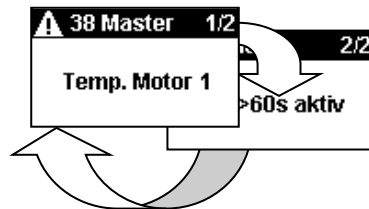

E



Temporäre Rückkehr in die Hauptansicht für 4 s nach dem Blättern in den Störungsanzeigen.

E



Any current operational faults in the drive system will be displayed in the Standard screen.

The display changes between normal/inverse after 2 s

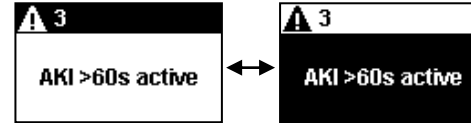

If several faults are active, they will be numbered:
e.g. Fault 1/2

E



Temporary return to the Standard screen for 4 s.

MASTER/SLAVE INSTALLATIONS

You can switch between the current fault of the Master and Slave drives.

Browsing the fault screens

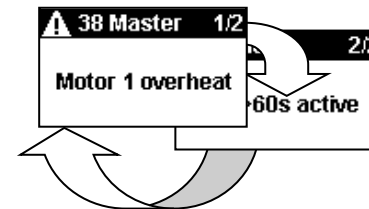

E



Temporary return to the Standard screen for 4 s after browsing the fault screens.

E



Les dysfonctionnements actuels du système d'entraînement s'affichent à l'écran principal.

Au bout de 2 s, l'affichage passe de normal à inverse.

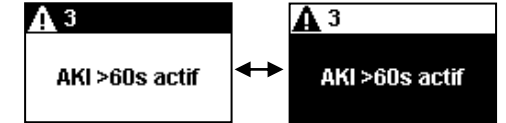

Si plusieurs dysfonctionnements sont actifs, ils seront alors numérotés :
par ex. erreur 1/2 .

E



Retour à l'écran principal pour 4 s.

INSTALLATIONS MAITRE/ESCLAVE

Il est possible d'alterner entre les dysfonctionnements actuels de l'entraînement Maître et Esclave.

Naviguer dans les erreurs

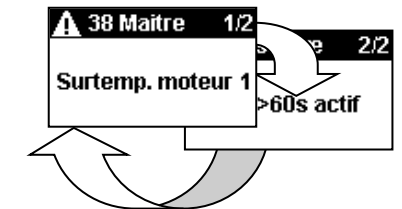

E



Retour à l'écran principal pour 4 s après naviguer dans les erreurs.

E



11**BEDIENSPERRE**

Das unerwünschte Manipulieren an der Bedieneinheit durch nicht autorisierte Personen kann auf einfache Weise erschwert werden.

BEDIENSPERRE ÜBER TASTATUR

Tastenfolge zum Sperren/Entsperren:

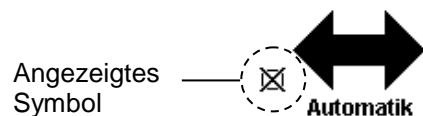
**ELEKTRONISCHE BEDIENSPERRE**

Zur Aktivierung der elektronischen Bediensperre die Verbindung zwischen J2 / 1-2 öffnen (siehe Anschlussschema).

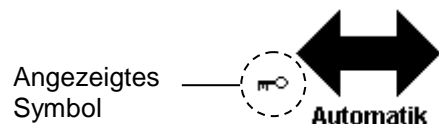
**BEDIENSPERRE ANSCHLIESSEN**

Wird eine Bediensperre angeschlossen, muss die Verbindung an der Leiterplatte (PCB) ausgebrochen werden!

**11****CONTROL LOCK**

Undesirable manipulations on the control unit by unauthorised persons can be hindered in a simple manner.

CONTROL LOCK VIA KEYPAD

Key sequence for locking/unlocking:

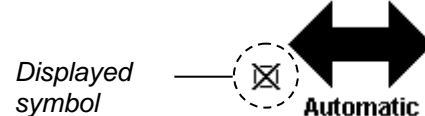
**ELECTRONIC CONTROL LOCK**

To activate the electronic control lock, open up the connection between J2 / 1-2 (refer to the connection diagram).

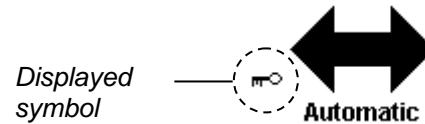
**CONNECTING CONTROL LOCK**

If a control lock is connected, the connection on the printed circuit board (PCB) must be broken out!

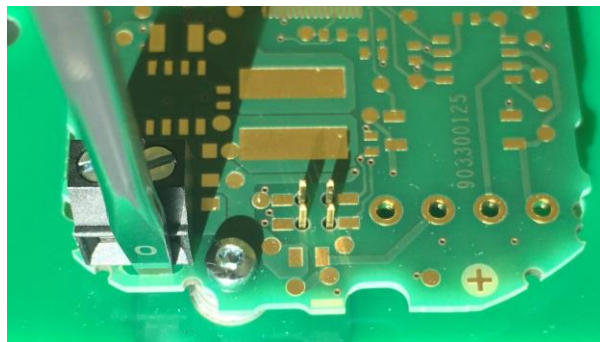
**11****BLOCAGE DE COMMANDE**

Il est possible d'empêcher de manière simple toute manipulation inopportune de l'unité de commande par des personnes non autorisées.

VERROUILLAGE PAR TOUCHES

Séquence pour verrouiller/déverrouiller

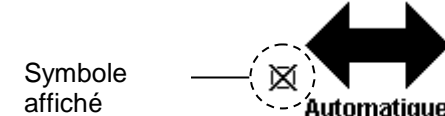
**VERROUILLAGE DE CDE. ELECTR.**



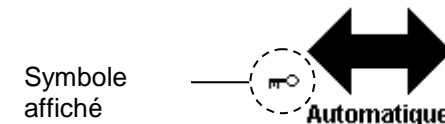



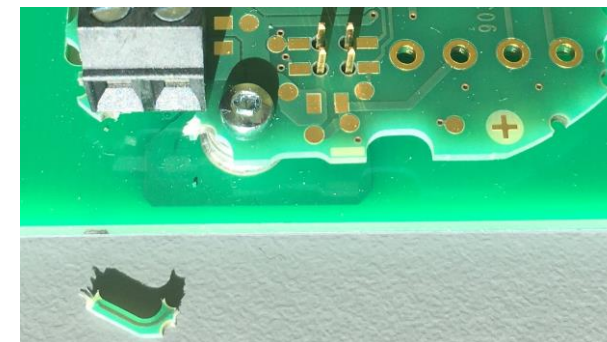



Pour activer le verrouillage de commande électronique, ouvrir la liaison entre J2 / 1-2 (voir schéma de raccordement).

**CONNECTER LE BLOCAGE DE COMMANDE**

Si un blocage de commande est connecté, la connection sur le circuit imprimé (PCB) doit être rompue !













BEISPIEL SCHLISSGESCHW.

-    Zugriff auf die Parameter in der Benutzerebene
-  Im Menu **Fahrkurve** zu Menüpunkt **Schliessgeschwindigkeit** und bestätigen
-   Im Menüpunkt **Schliessgeschwindigkeit** die gewünschte Geschwindigkeit auswählen
-  Geschwindigkeit erhöhen
0 = Minimum
40 = Maximum
-  Geschwindigkeit vermindern
-  **Taste gedrückt halten für kontinuierliches Verschieben**
-  Wert übernehmen und im STG speichern
-  Menüpunkt verlassen
C







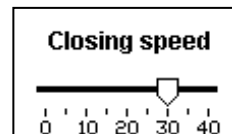
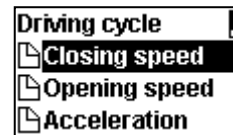
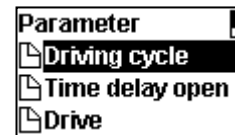





CLOSING SPEED EXAMPLE

-    Access to the parameter at end customer level
-  In the **Driving cycle** menu, select the **Closing speed** menu item, and confirm
-   Select the desired speed in the **Closing speed** menu item
-  Increasing the speed
0 = minimum
40 = maximum
-  Decreasing the speed
-  **Hold the key down for continuous scrolling**
-  Confirm the entry and save it in the STG
-  Exit the menu item
C



EXEMPLE VITESSE FERMETURE

-    Accès aux paramètres à l'échelon du client final
-  Choisir **Vitesse fermeture** dans le menu **Courbe de mouvement** et confirmer
-   Choisi la vitesse souhaité dans le menu **Vitesse fermeture** et confirmer
-  Augmenter la vitesse
0 = minimum
40 = maximum
-  Diminuer la vitesse
-  **Maintenir la touche pressée pour obtenir un déroulement continu**
-  Valider et enregistrer dans la STG
-  Quitter article de menu
C

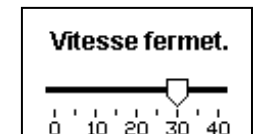
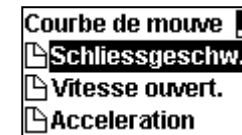
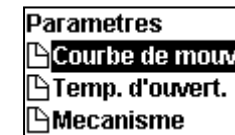

Symptom / Fehler

- ! Mögliche Ursache
- Massnahmen

Keine Anzeige nach Verbindung mit STG

- ! Falsches Verbindungskabel , falsche Steckerbelegung
- Anschlüsse der CAN-Verbindung überprüfen

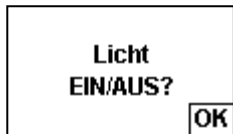
Anzeige nach Verbindung mit STG

- ! Nur Testprogramm geladen
- Testprogramm beenden, SW update mit FPC 902

Anzeige schlecht lesbar

- ! Kontrast zu tief oder zu hoch eingestellt
- Parameter/Bedieneinheit/BDE-D/Kontrast anpassen

"?" in der Anzeige / bei Parameter

- ! Wert im STG unbekannt oder nicht vorhanden
- Parameter programmieren oder STG updaten

Symptom / error

- ! Possible causes
- Remedy

No display after connection to the STG

- ! Wrong cable connector, incorrect pin configuration
- Check connections to the CAN bus

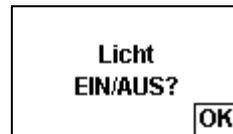
Display after connection to the STG

- ! Only test routines are existing
- Finish test routines, software update with FPC 902

Display is not easily readable

- ! Contrast may be to low or to high adjusted
- Parameter/Control panel/BDE-D/ adjust contrast

"?" on display / in parameter value

- ! Unknown parameter in the STG or inexistent
- Parameter programmieren oder STG updaten

Symptôme / erreur

- ! Cause probable
- Remède

Pas d'affichage après connexion avec STG

- ! Faux câble de connexion, fausse connexion de prise
- Vérifier les connexions au bus CAN

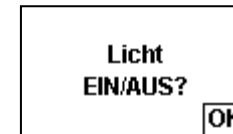
Affichage après connexion avec STG

- ! Routine de test existe seulement
- Terminer la routine de test, mise à jour le logiciel avec le FPC 902

Mauvais visibilité d'affichage LCD

- ! Contrôle de contraste peut être trop bas ou trop haut
- Parametres/Unité de commande/BDE-D/ ajuster le contraste

"?" sur l'affichage / au paramètre

- ! Valeur inconnue dans le STG ou inexistante
- Programmer le paramètre ou mettre le STG à jour