

Translation of the original manual

User manual

Document identification

Article nr.: 102-127401806
Version: V1.0
Publication date: 01/02/2022

Subject to technical modifications

Copyright © agtatec ag

Table of contents

Glossary	4
1 Safety	5
1.1 Presentation of warning signs	5
1.2 Intended purpose of use	5
1.3 General hazards	5
1.4 State of technology	8
1.5 Spare parts and liability	8
2 General information	9
2.1 Purpose and use of the instructions	9
2.2 Copyright	9
2.3 Product identification	9
2.4 Manufacturer agtatec ag	9
2.5 Target groups	10
2.6 Definition of terms	10
3 Description	11
3.1 Overview	11
3.2 Types of arm	12
3.3 Low energy drive (Low Energy)	12
3.4 Functions	12
3.5 Primary / secondary application	13
3.6 Control panel	13
3.7 Battery pack (optional)	14
4 Specifications	15
4.1 Technical data	15
5 Operation	16
5.1 Toggle switch BDI	16
5.1.1 Control elements and displays	16
5.2 Control panel BDE-D	16
5.2.1 Operation modes and button functions	16
5.2.2 Perform reset	18
5.2.3 Display system information	19
5.2.4 Lock control panel	19
5.2.5 Set parameters	20
5.2.6 Description of parameters	21
6 Malfunctions	23
6.1 Status displays	23
6.2 Troubleshooting	23
7 Maintenance and servicing	25
7.1 Test log book	25
7.2 General remarks	25
7.3 Operator duties	25
7.4 Spare parts and wearing parts	26

Glossary

Glossary

BDE

Control panel

BDE-D

Bedienungseinheit mit Display

BDE-M

Control panel mechanical

BDI

Control unit with toggle switch

BDI-M

Print for mechanical control unit

NET

Power supply

SSK

Key pivot contact

STG

Control unit

1 Safety

1.1 Presentation of warning signs

Various symbols are used in this guide for easier understanding:



NOTICE

Useful advice and information to ensure correct and efficient workflow of the system.



IMPORTANT

Specific details which are essential for trouble-free operation of the system.



IMPORTANT

Important details which must be read for proper function of the system.



CAUTION

Against a potential hazardous situation that can lead to minor personal injury and property damage.



WARNING

Against a latent hazardous situation that can lead to severe injuries or death and cause substantial property damage.



DANGER

Against an imminent hazardous situation that can lead to severe injury or death.



DANGER

Against an imminent or latent hazardous situation that could lead to electric shock and cause serious injury or death.

1.2 Intended purpose of use

The system is designed exclusively for use as a pedestrian passage. The installation must only occur in dry areas. If there are deviations then proper waterproofing and water drains will be required on-site.

Any other application or use beyond this purpose is not considered to be an intended purpose. The manufacturer bears no liability for any resulting damage; the operator alone shall bear the associated risk.

The intended purpose also includes observation of the operating conditions specified by the manufacturer, in addition to regular care, maintenance and repair.

Interventions in or alterations to the installation performed by non-authorized maintenance technicians exclude the manufacturer's liability for consequential damages.

1.3 General hazards

The following section lists hazards that can be caused by the system even when used as intended.

To reduce the risk of malfunction, damage to property or injury to persons and to avoid dangerous situations, the safety instructions listed here must be observed.

The specific safety instructions in the other sections of this manual must also be observed.



IMPORTANT

The country-specific regulations must be observed and complied with!



IMPORTANT

To avoid malfunctions, moving objects such as flags or parts of plants must not be allowed to enter the detection range of the sensors.



CAUTION

Risk of malfunctions, material damage or injury due to improper settings!

- a) Improper settings can lead to malfunctions, material damage or personal injury.
 - ⇒ Do not disconnect the system from the power supply overnight.
 - ⇒ Settings should only be made by personnel qualified to do so.
 - ⇒ Do not disassemble, put out of operation or manipulate safety devices.
 - ⇒ Have faults rectified by specialist personnel or by personnel qualified to do so.
 - ⇒ Have service and maintenance carried out according to locally applicable regulations or according to a maintenance contract.



CAUTION

Risk of malfunctions, material damage or injuries due to insufficient or missing cleaning or care!

- a) Insufficient or inattentive cleaning or care of the system can lead to malfunctions, damage to property or injury to persons.
 - ⇒ Check the sensors regularly for dirt and clean them if necessary.
 - ⇒ Regularly remove dirt accumulations in the floor rail or under the floor mat.
 - ⇒ Keep the system free from snow and ice.
 - ⇒ Do not use aggressive or caustic cleaning agents.
 - ⇒ Use road salt or loose chippings only conditionally.
 - ⇒ Lay the floor mat without folds and flush with the floor.
 - ⇒ Equipment required for cleaning purposes such as ladders or similar must not be leaned on or attached to the system.



CAUTION

Risk of material damage or injury due to unforeseen opening, closing or turning of the door!

- a) The door can open, close or turn unexpectedly. This may result in damage to property or injury to persons.
 - ⇒ No persons may be present in the opening area of the system.
 - ⇒ Ensure that moving objects such as flags or parts of plants do not enter the detection range of the sensors.
 - ⇒ Do not make any settings on the control unit when the system is in use.
 - ⇒ Have faults rectified immediately by specialist or personnel qualified to do so.
 - ⇒ Remove objects from the opening area.
 - ⇒ Do not disassemble, put out of operation or manipulate safety devices.
 - ⇒ Do not rush through a closing system.



CAUTION

Risk of bruising and severing of limbs!

- a) If the system moves, careless behaviour can lead to serious injuries to limbs or severance of limbs.
 - ⇒ Do not reach in when parts of the system are moving.
 - ⇒ Keep a distance when parts of the system move.
 - ⇒ Do not bump into or touch the system when it is moving.
 - ⇒ Do not open or remove protective covers during operation.
 - ⇒ Do not permanently remove covers from the system.
 - ⇒ Only carry out inspection, service, maintenance and cleaning when the system is stationary and switched off.



CAUTION

Danger of material damage or injury due to non-functioning safety devices!

- a) If safety devices are not functioning, manipulated or put out of operation, there is a risk of damage to property or injuries that can lead to death.
 - ⇒ Never disable or manipulate safety devices.
 - ⇒ Have inspection, service and maintenance of the safety devices carried out according to local regulations or according to a maintenance contract.



CAUTION

Danger of malfunctions, damage to property or risk of injury if used by unauthorised persons!

- a) If unauthorised persons use the system, there is a risk of malfunction, damage to property or injury to persons.
 - ⇒ Children under 8 years of age may only use the system under supervision.
 - ⇒ Children must not play, clean or maintain the system.
 - ⇒ Persons with limited physical, sensory or mental abilities as well as persons with insufficient knowledge or experience may only use the system under supervision or must have received and understood instructions to do so.



DANGER

Danger to life due to electric current!

- a) In case of contact with live parts, there is an immediate danger to life due to electric shock. Damage to or removal of the insulation or individual components can be life-threatening.
 - ⇒ Before starting work on active parts of electrical systems and equipment, ensure that all poles are voltage free and that this is maintained for the duration of the work.
 - ⇒ Keep moisture away from live parts. This can lead to a short circuit.
 - ⇒ Never bridge fuses or put them out of operation.
 - ⇒ Do not connect the power supply until all work has been completed.
 - ⇒ Have work on the electrical system performed by qualified personnel only.



DANGER

Danger to life due to non-functioning safety devices of the fire protection system!

- a) If safety devices of the fire protection system do not function properly, there is a risk of serious or fatal injuries.
 - ⇒ Never disconnect the fire protection system from the power supply overnight.
 - ⇒ Do not disassemble, put out of operation or manipulate safety devices.
 - ⇒ Do not remove safety instructions on the system.
 - ⇒ Never block, hold open or otherwise prevent fire doors from closing.
 - ⇒ Have inspection, service and maintenance of the fire protection system carried out in accordance with locally applicable regulations or according to a maintenance contract.
 - ⇒ Have the fire protection system checked and maintained according to the state of the art.

1.4 State of technology

This system was developed using state of the art technology and officially recognized technical safety regulations. The system, depending on its options and diameter, comply with the requirements of the Machine Guidelines 2006/42/EG as well as EN 16005 and DIN 18650 (D).

Nevertheless, danger may arise if not used as intended.



IMPORTANT

Installation, commissioning, inspection, maintenance and repair work may only be conducted by qualified, trained and authorized technicians.

After commissioning or repair work, fill in the check list and give it to the customer for safe keeping.

We recommend obtaining a service agreement.

1.5 Spare parts and liability

Reliable and trouble free operation of the door is only guaranteed when using parts that were recommended by the manufacturer. The manufacturer declines any liability for damages resulting from unauthorized modifications to the door or the use of parts that are not permitted.

2 General information

2.1 Purpose and use of the instructions

These instructions are an integral part of the system and enable efficient and safe handling of the system. In order to ensure proper functioning, the instructions must be accessible at all times and kept in the immediate area of the system.

Although only the male form has been chosen for reasons of better legibility, the information refers to members of both sexes.

The operator must have read and understood the manual before starting any work. The basic requirement for safe working is to follow the safety instructions and the handling instructions. In addition, the local regulations and safety rules apply.

The manual can be handed over in extracts to instructed personnel who are familiar with the operation of the system.

The illustrations are for basic understanding and may differ from the actual presentation. Specific representations are contained in the drawings.

2.2 Copyright

The copyright for these instructions remains with:

agtatec ag

The instructions may not be reproduced, distributed, or used for the purpose of competition without the written consent of agtatec ag.

Infringements shall result in the obligation to pay damages.

2.3 Product identification

For precise identification, please refer to the nameplate attached to the inside of the casing or to the operator displaying the following information:

Example:

Type:

Serial number:

Year of construction:

Mains connection:

Power consumption:

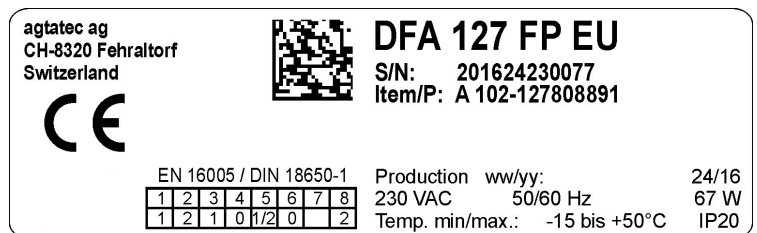

Classification according to 18650-1:2005:

Marking:

2.4 Manufacturer agtatec ag

agtatec ag

Allmendstrasse 24

CH – 8320 Fehraltorf

Switzerland

Phone: +41 44 954 91 91

Fax: +41 44 954 92 00

2 General information

2.5 Target groups



CAUTION

Risk of injury if personnel are insufficiently qualified!

If unqualified personnel work on the system or are in the danger zone of the system, dangers may arise which can cause serious injuries and considerable damage to property.

- a) All work must be carried out by qualified personnel only.
- b) Keep unqualified personnel away from danger areas.

This operating manual is intended for the target groups listed below:

- Operating entity of the system:
the person who is responsible for the technical maintenance of this system
- Operator of the system:
the person who operates the system every day and has been suitably instructed

2.6 Definition of terms

Term:	Explanation:
System	The term is also used in these instructions as a synonym for the product. Door operators, revolving doors, sliding doors, etc. are referred to as a system. If information in these instructions refers to a specific type, this is shown accordingly in the text.
User	Users are all persons who use the system.
System operator	The respective owner is referred to as the system operator, regardless of whether they operate the system as the owner or pass it on to third parties.
Authorized representative	The authorized representative takes over certain parts of the manufacturer's obligations with regard to fulfilling the requirements of the Machinery Directive. In particular, the authorized representative may also place the system on the market and/or sign EC declarations of incorporation.

Qualified personnel are authorized and appropriately trained to perform the following work:

- Disassembly, Assembly, Commissioning, Operation, Audit, Maintenance, Troubleshooting, De-commissioning

The qualified personnel have several years of professional experience in the technical field, e.g. as mechanics or machine fitters.

The qualified personnel are aware of the residual risks arising from the installation site and, due to their professional training, knowledge and experience, are able to carry out the work assigned to them and to independently identify and avoid possible danger points.

Manufacturer	The manufacturer is whoever designs and/or builds machinery or incomplete machinery under the scope of the Machinery Directive.
Life phases	All phases of the system's condition and use are referred to as life phases. This applies from the time the system leaves the factory until it is disposed of.
Personnel	All persons who carry out activities on and with the system are referred to as personnel. Personnel can be, for example, the operator, the cleaning staff, or the security staff. The personnel meet the personnel qualifications required by the manufacturer.

3 Description

3.1 Overview

The swing door operator DFA 127 (hereinafter referred to as operator), is a self-monitored, microprocessor-controlled swing door operator. It can be used in a multitude of ways thanks to its special and additional functions.

The microprocessor analyzes the current door position, door speed, and target position and calculates the movement sequence. This means that there are no jerky braking movements or creep rate, and end stops for the door are eliminated. The spring force must be adjusted depending on door leaf width.

Set parameters [▶ 20]

Description of parameters [▶ 21]

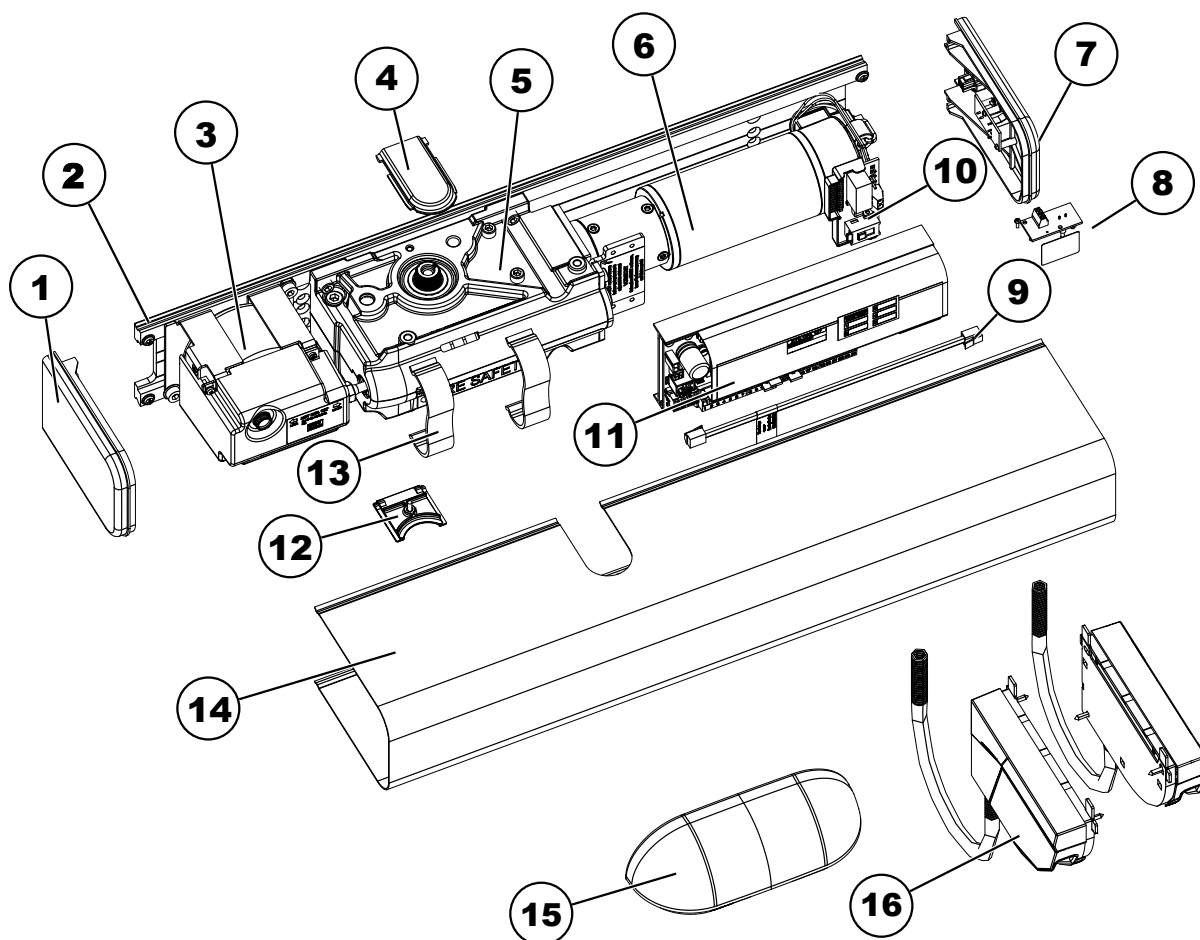

1 Side cover	2 Chassis
3 Power supply unit NET	4 Shaft cover
5 Drive group ATG	6 Motor MOT
7 Side cover with toggle switch	8 Print for mechanical control panel BDE-M (option)
9 Cable SIP 220 mm	10 Motor print
11 Control device STG	12 Wedge
13 Cable clip	14 Casing
15 Sensor RAD 290 (option)	16 Sensor BEA Flatscan left and right (option)

3 Description

3.2 Types of arm

Power is transmitted from the operator to the door leaf by means of an arm. Depending on the installation situation, a standard arm or a sliding arm may be suitable. Standard arms are available in various lengths to adjust the recess depth. Varying over heights are adjusted with the lever sockets (shaft extensions).

Standard arm SG

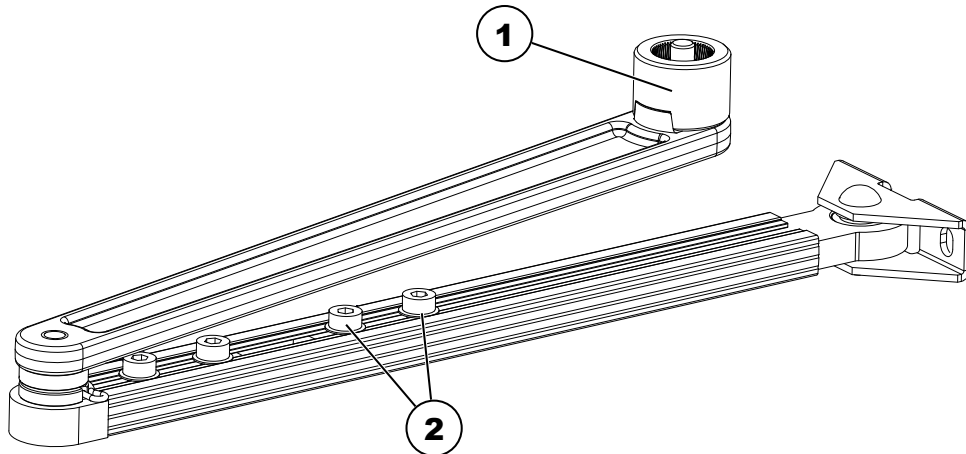

1 Lever socket

2 Adjusting screw length

Sliding arm GG

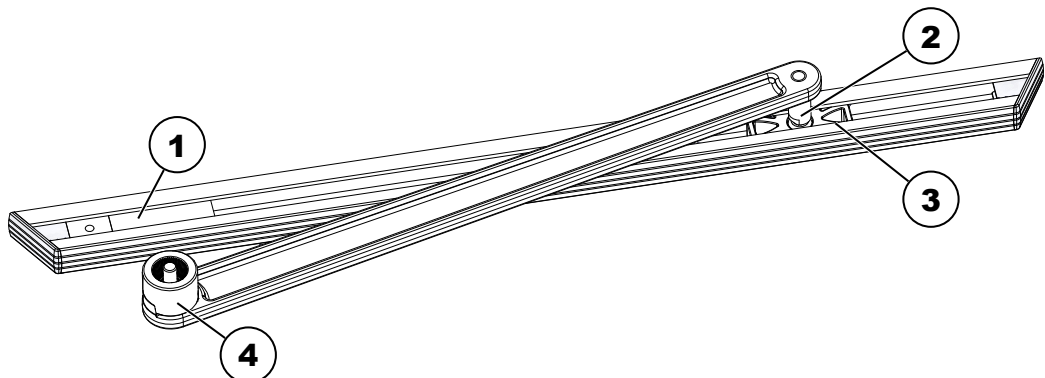

1 Stop plate with damper stop

2 Pin shaft

3 Slide shoe

4 Lever socket

3.3 Low energy drive (Low Energy)

Parameterization makes it possible to use the operator as a low-energy operator.

The door is closed with reduced spring force. The opening and closing speeds can be adjusted to a limited extent and the operator reacts more sensitively in the event of a collision. To prevent accidental or improper changes to the programming, access to the parameters is restricted for users.

Only qualified personnel may carry out the parameterization of the operator.

3.4 Functions

Obstacle detection: If the door hits an obstacle when opening, it stops immediately and saves the position of the collision. During the hold open time, the operator briefly attempts to reach the open position. Once the hold open time has elapsed, the door closes and the obstacle position is passed over more slowly the next time it opens. This prevents another hard impact.

Reversing: If the door hits an obstacle when closing, a reopening is initiated immediately (reversing). The obstacle position is saved in the door operator and this position is approached gently the next time the door is closed.

Operation: Three operation modes can be set using the built-in toggle switch **BDI** [Toggle switch **BDI** ▶ 16].

Primary / secondary: A primary / secondary system can only be operated via the toggle switch **BDI** of the primary operator. This switch position also affects the secondary operator.

3.5 Primary / secondary application

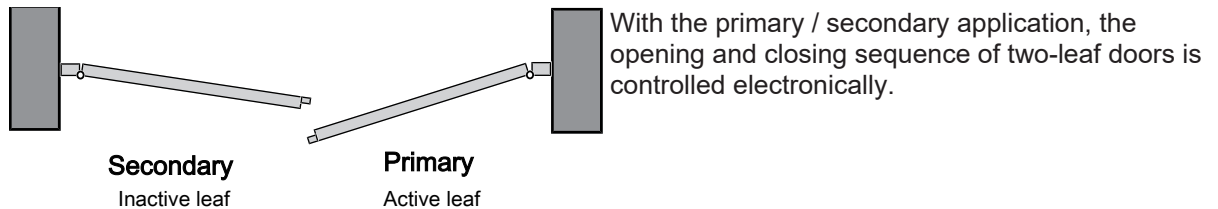

For two-leaf fire doors, the mechanical door selector SFR 127 is additionally installed for the inactive leaf and the active leaf.

The two operators communicate with each other via an interface so that the safety functions such as reversing and obstacle detection remain in place.

The closing sequence control can only be used with operator height 108 mm.



NOTICE

The functions of the primary / secondary operator correspond to those of a standard operator.

3.6 Control panel

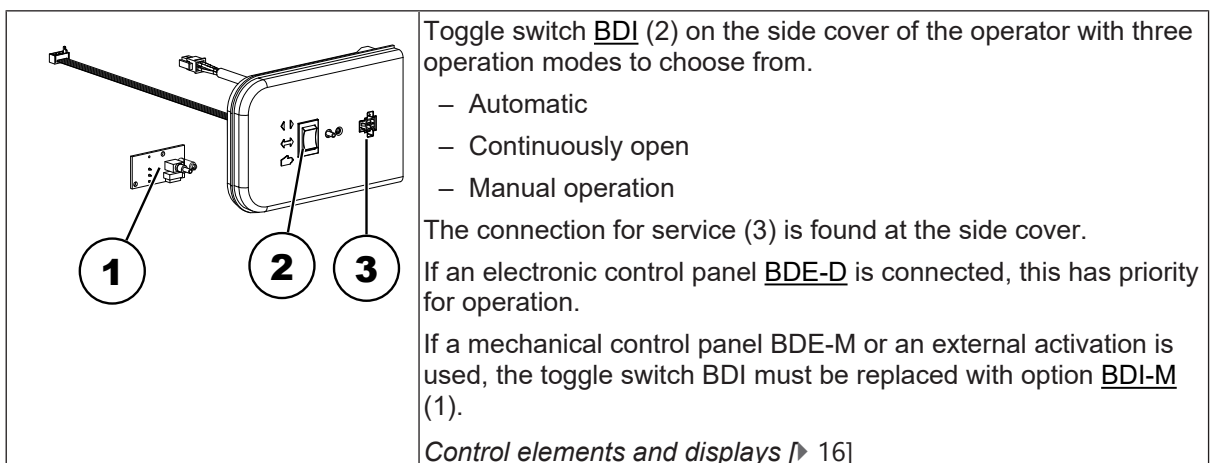

3 Description

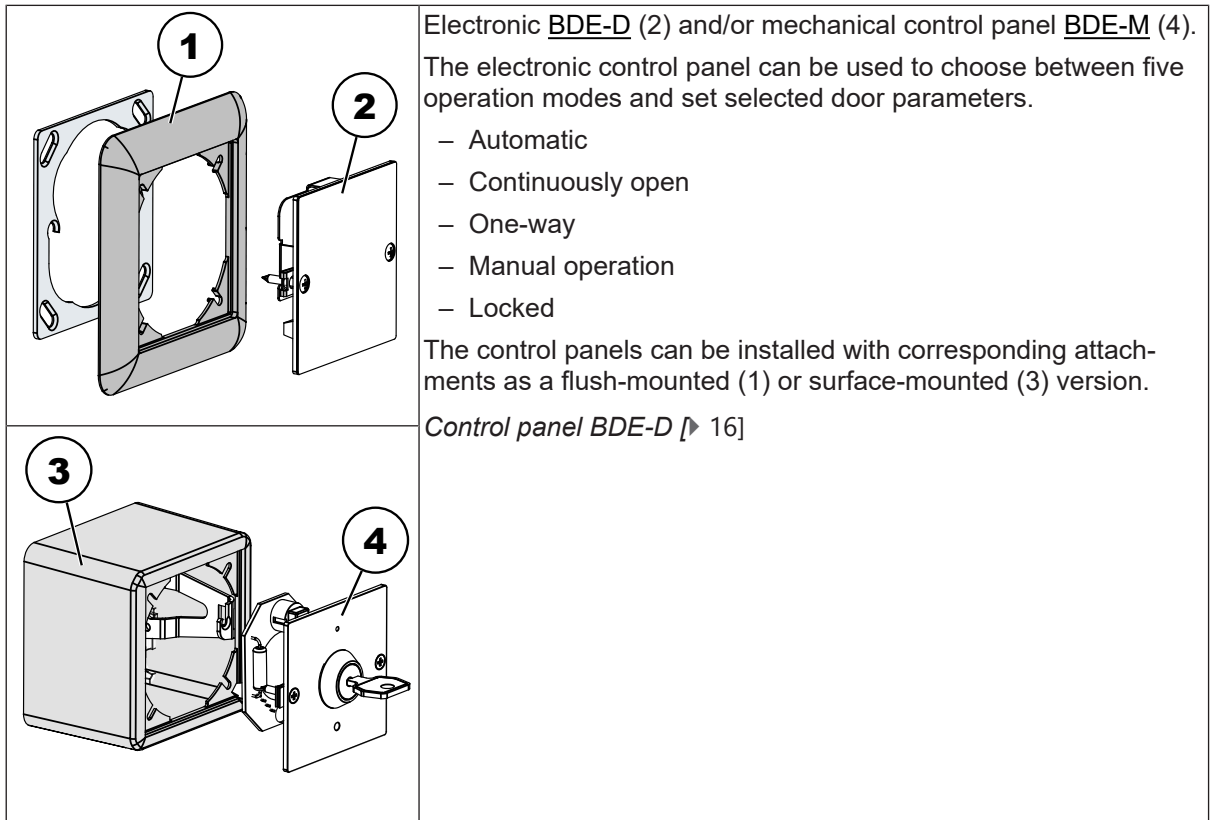

3.7 Battery pack (optional)

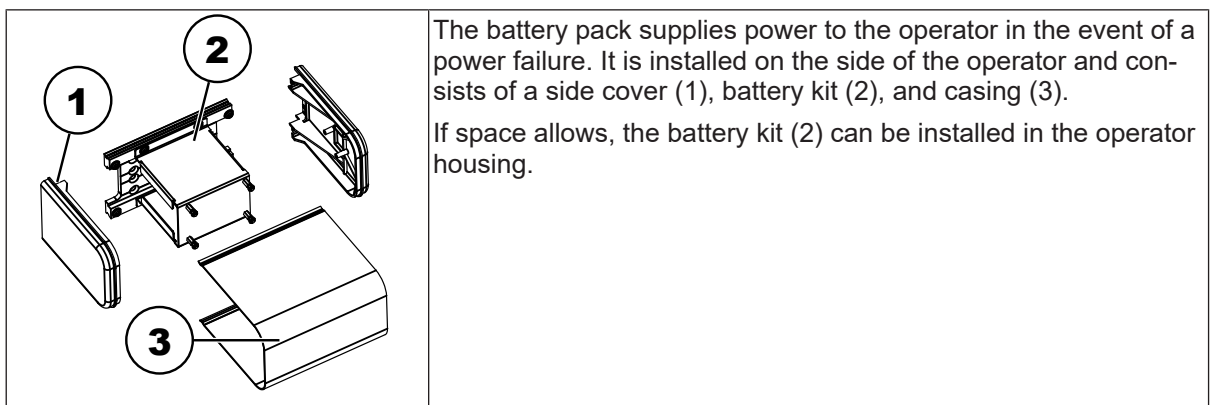

4 Specifications

4.1 Technical data

Operating voltage:	230VAC, 50/60 Hz
Power consumption:	Standby 13 W, rated power 67 W
Max. torque:	50 Nm
Max. Mass inertia door leaf:	65 kgm ²
Opening angle:	70° - 115°
Hold open time	0 to 60 seconds (40 steps)
Opening speed:	3 to 20 seconds (40 steps)
Closing speed:	5 to 20 seconds (40 steps)
Noise generation:	< 45 dB
Degree of protection:	IP20
Temperature range:	From -15 to +50° C
Humidity range:	Up to 85% rel. humidity, not condensing

5 Operation

5 Operation

5.1 Toggle switch BDI

5.1.1 Control elements and displays

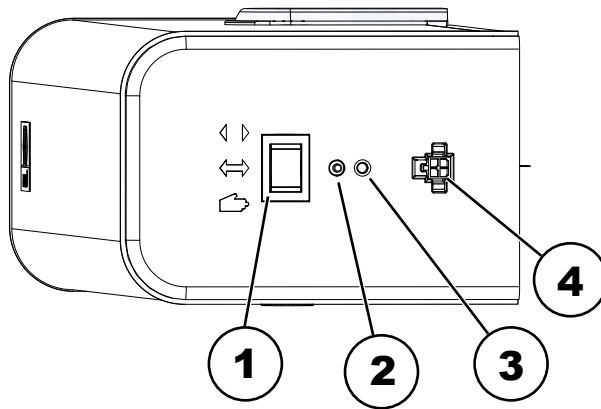

1 Toggle switch BDI

2 Reset button

3 Status display LED

4 Connection for configuration tool

Toggle switch BDI

Three operation modes can be selected using the toggle switch:



Manual operation:

The operator works like a door closer. It can be opened manually and closes independently. The connected sensors are disabled.



Automatic:

In the "Automatic" operation mode, the door opens with the aid of a trigger device/sensor or when pushed when the touch control is activated. The door closes after the hold open time has elapsed, unless a new opening impulse is given.



Continuously open:

The door remains open.

If the door encounters an obstacle when opening, the operator attempts to open the door. If the obstacle does not move, the current position is recognized as continuously open.

The toggle switch is always active. If an electronic control panel BDE-D is connected, the operation mode is determined by this.

Reset button

When pressed for 5 seconds, this button resets the control device.

Status display LED

- When LED is off the operator is ready to use.
- Flashes when an error occurs during operation.









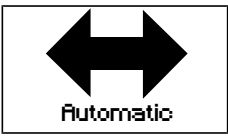

5.2 Control panel BDE-D

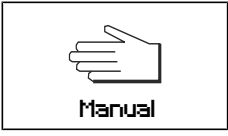
5.2.1 Operation modes and button functions

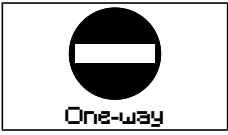
The buttons on the control panel BDE-D are used to set the door system operation modes in the main menu. The parameters of the door system are set in the sub menu.

The button functions are divided into main menu and sub menu.

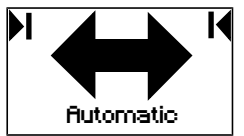
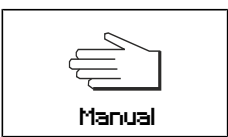
Main menu







Button	Name	Operation	Function	Display on LCD
	Automatic button	Press button 1 x	Automatic operation via sensors	
	Continuously open button	Press button 1 x	For sliding door operator and swing door operator: continuously open, sensors disabled	
		Press button 2 x or hold it down for 2 seconds	For sliding door operator: manual operation	
	One-way button	Press button 1 x	Passage only possible from one direction	
	Locking button	Press button 1 x	Door closed, sensors disabled	
		Press button again	The door opens again, closes, and locks again. Can be opened with a key (optional).	
	Star button	Press button 1 x	For sliding door operator: Reduced open width	
		Press button 1 x	For swing door operator: manual operation	
E 	Menu button	Restart control device: press button for 5 seconds Restart hardware BDE-D: press button for 12 seconds	Access to parameter menu Enable control lock Restart control device Restart hardware BDE-D	

Sub menu

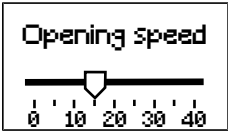
NOTICE

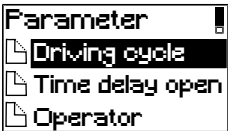
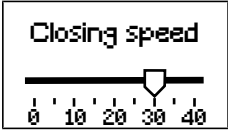

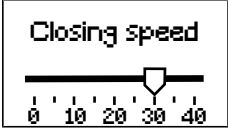
The main menu is returned to automatically 3 minutes after the last entry.

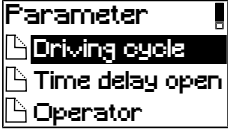
5 Operation

Button	Name	Operation	Function	Display on LCD
	Enter button	Press button 1 x to go to the next sub menu.	Select menu item, confirm entry	
	Plus button	Press button 1 x to go down.	Navigate downwards in the menu	
		Press button 1 x to increase the value.	Move the slide control to the right to increase the value	
	Minus button	Press button 1 x to go up.	Navigate upwards in the menu	
		Press button 1 x to reduce the value.	Move the slide control to the left to reduce the value	
 c	Clear button	Press button 1 x to go to the previous menu.	Leave the menu item without saving.	

5.2.2 Perform reset

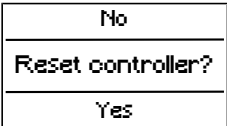
Reset controller

Step	Button	Operation	Function	Display on LCD
1.		Press button for 5 seconds	Perform controller reset	
2.	 c	Press button 1 x	Cancel reset	
		Press button 1 x	Perform reset	

Reset control panel

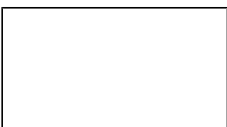
Step	Button	Operation	Function	Display on LCD
1.		Press button for 12 seconds	Perform control panel reset	

Step	Button	Operation	Function	Display on LCD
2.				
3.			The connection has been established	

5.2.3 Display system information

Information about the door system, such as software version, door type, or servicing status, can be shown on the display.



NOTICE

The main view is returned to by scrolling or automatically after 20 seconds.

Step	Button	Operation	Function	Display on LCD
1.	E 	Press button for approx. 2 seconds	Software information is displayed	
2.	E 	Press button 1 x	Scroll through the information and/or return to main view	
3.	E 	Press button 1 x	Scroll through the information and/or return to main view	

5.2.4 Lock control panel

Enable control lock on the keyboard

Step	Button	Operation	Function	Display on LCD
1.	E 	Press the button sequence as shown	No settings can be made on the control panel <u>BDE-D</u> .	
		To disable, press the button sequence again		

5 Operation

Enable control lock with key

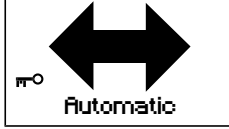
Step	Requirement	Operation	Function	Display on LCD
1.	The desired operation mode is set.	Enable/disable the control lock with the key	No settings can be made on the control panel <u>BDE-D</u> .	









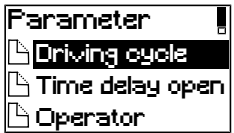

5.2.5 Set parameters



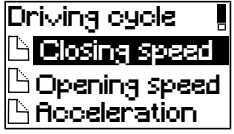

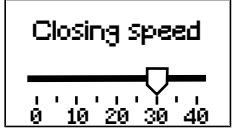
IMPORTANT

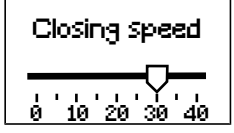
With the type "low energy", the parameters can only be changed by qualified personnel.

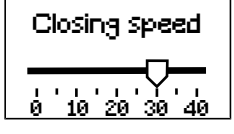
The following example of the closing speed explains how to set the parameters of the door.

Step	Button	Operation	Function	Display on LCD
1.	E 	Press the buttons in the order shown	Access to the parameters in the sub menu	
				
	E 			
2.	+ 	Press the buttons in the order shown	In the sub menu, access the parameter closing speed	
	E 			
3.	+ 	Set the closing speed with the buttons shown. Hold down the button to move continuously	Increase speed 0 = minimum speed 40 = maximum speed	
	- 			
6.	E 	Press button 1 x	Save value	
	 C	Press button 1 x	Leave without saving	

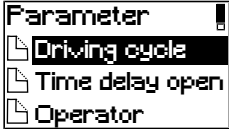
Step	Button	Operation	Function	Display on LCD
7.		Press button 1 x	Check settings (door opens and closes again)	
8.	 c	Press button 1 x Press several times to jump to the beginning of the sub menu	Leave sub menu	

5.2.6 Description of parameters



IMPORTANT

With the type "low energy", the parameters can only be changed by qualified personnel.

W = Factory parameter: **basic operator** (FP)

PARAMETER	W	Comment
DRIVING CYCLE		
→ closing speed	18	Speed when closing the door. 0 = lowest speed 40 = highest speed – The maximum speed depends on the opening angle and acceleration.
→ opening speed	36	Speed when opening the door. 0 = lowest speed 40 = highest speed – The maximum speed depends on the opening angle and acceleration. – DIN: >1.5 s <4 s
TIME DELAY OPEN		
→ time delay open	2	Determines how long the door remains open after it has been opened by a trigger signal. 0..20 = 0 to 20 seconds, increment 1 s 21..40 = 22 to 60 seconds, increment 2 s – The time delay open starts when all trigger and safety signals for closing stop.
→ SSK time delay open	5	Determines the minimum time the door remains open after it has been opened by a trigger signal of the type <u>SSK</u> . 0..20 = 0 to 20 seconds, increment 1 s 21..40 = 22 to 60 seconds, increment 2 s – The hold open time starts when all trigger and safety signals for closing stop.



NOTICE

The time delay open can be reduced if sensors are used that hold the door open, e.g. *hold time*.

5 Operation

OPERATOR

→ opening angle	35	The opening angle is determined during the teach-in run and corresponds to the value 40. 0 = minimum opening angle 40 = maximum opening angle – DIN : min. 95°
-----------------	----	--

6 Malfunctions

6.1 Status displays

Malfunctions are shown on the LCD display. If there is a malfunction, the display changes between light and dark, as shown in the following figure. Multiple malfunctions can be displayed, e.g. 1 / 2. If there are multiple malfunctions, they are numbered as follows.

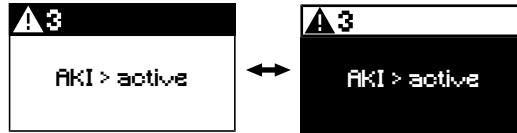

Step	Button	Operation	Function	Display on LCD
1.	E 	Press button 1 x	Return to the main menu for 4 seconds	

Malfunction display for primary / secondary operator

It is possible to switch between the malfunction display of the primary / secondary operator
The main view is returned to by scrolling through the malfunction displays.

Step	Button	Operation	Function	Display on LCD
1.	E 	Press button 1 x	Scroll through the malfunction displays	

6.2 Troubleshooting

The following malfunctions on the door can only be rectified if an electronic control panel with display is present.

Malfunction	Cause	Measure	Personnel
Display shows a malfunction message.	Malfunction present	Restart controller and/or control panel. <i>Perform reset [▶ 18]</i>	System operator
Door does not work.	No power connected.	Check power connection	System operator
	Incorrect operation mode selected.	Check operation mode. <i>Operation modes and button functions [▶ 16]</i>	System operator
	Status LED flashing	Restart controller and/or control panel. <i>Control elements and displays [▶ 16]</i>	System operator
	Malfunction message on the display of the <u>BDE-D</u>	Restart controller and/or control panel. <i>Perform reset [▶ 18]</i>	System operator
	Defective	Close the door manually and notify a service engineer. <i>Operation modes and button functions [▶ 16]</i>	System operator

6 Malfunctions

Malfunction	Cause	Measure	Personnel
Malfunction message still present after restart.	Malfunction could not be rectified.	Qualified personnel are required to rectify the malfunction.	Qualified personnel
		Show and read out system information about the door on the display. <i>Display system information [▶ 19]</i> Notify service center. If necessary, close the door manually. <i>Operation modes and button functions [▶ 16]</i>	System operator
Beep every 5 seconds (only with battery pack option)	No power present.	Switch on the mains power supply.	System operator
	Mains fuse defective.	Replace the fuse.	System operator
	Fuse on the operator's power supply unit defective.	Replace the fuse.	Qualified personnel

7 Maintenance and servicing

7.1 Test log book

The scope, result, and time of testing and servicing must be documented in a test log book and service book. The system operator must store the test log book until the next testing and servicing.

Testing is carried out by qualified personnel using the manufacturer's testing instructions.

7.2 General remarks

According to current legislation, the operator of an automatic door system is responsible for its maintenance and safety.

Accidents or defects can be avoided if the system operator takes good care of the system.

Testing

Type of test	Measure
Visual inspection	Check door leaves, guides, bearings, limiting devices, sensors, and the securing of crushing and shearing points for damage.
Mechanical inspection	Check fastenings for tight fit.
Safety check (exit and escape routes)	Check sensors, safety devices, and monitoring devices for tight fit and damage.
Function testing	Check functioning of switches, operators, controllers, power or energy storage devices, and sensors. Also check the adjustment of the safety devices and the setting of all movement sequences including the end points.

Servicing

Type of servicing	Measure
Adjusting and cleaning	Clean and adjust bearings, sliding points, and power transmission.

For documentation and information purposes, the testing and servicing work as well as the condition of the system are recorded in a test log book. The test log book must be kept for at least one year or until the next testing/servicing.



IMPORTANT

The testing and/or servicing interval according to the manufacturer's specification is at least 1 to 2 times a year.



IMPORTANT

The recommended and planned spare parts and wearing parts can be requested from your service center.

7.3 Operator duties

Personal protection requires compliance with the standards and guidelines for publicly accessible facilities.

According to applicable standards and guidelines, automatic door systems must be tested and serviced by qualified persons.

The system operator is responsible for carrying out testing and servicing.

7 Maintenance and servicing

System operator tasks

Task	Personnel	When?	Entered in test log book?
Maintenance and cleaning of the sensors for safety and triggering	System operator	Weekly, or as required	No
Function and safety check	System operator	Monthly	No

Tasks of qualified person

Task	Personnel	When?	Entered in test log book?
Acceptance test	Qualified person	After assembly of the door system ready for operation	Yes
Servicing	Qualified person	1 x annually, or according to country-specific standards and guidelines	Yes
Test (inspection)	Qualified person	1 x annually, or according to country-specific standards and guidelines	Yes
Test (inspection) for door systems in escape routes	Qualified person	2 x annually, or according to country-specific standards and guidelines	Yes
Testing of fire doors	Qualified person	1 x annually, or according to country-specific standards and guidelines	Yes

7.4 Spare parts and wearing parts



NOTICE

Depending on the design of the system, not all spare parts and wearing parts are listed.

Spare part / wearing part	Interval
Slide shoe	3 years
Lever socket	3 years
Ball joint axle	If wear is detected
Support ring for lever socket	If wear is detected
Mounting set for stop	If wear is detected
Cable transmission	If wear is detected
Pushing flap (only for fire doors)	If wear is detected
Operator group ATG	If wear is detected
Power supply unit <u>NET</u>	If wear is detected
Controller <u>STG</u>	In the event of breakdown
Control panel <u>BDE</u>	In the event of breakdown



Subject to technical modifications
Copyright © agtatec ag
No. 102-127401806