

# record DFA 127

automatic drive system for swing doors



DFA 127



# DFA 127



**record**

your global partner for entrance solutions

## record DFA 127 – the universal drive system for swing doors

The record DFA 127 is a universal drive system for the automation of swing doors. It is characterized by sophisticated technology, compact design and especially record's legendary smoothness of operation. The focus on a broad range of applications makes it a full-fledged drive, suitable for widely differing requirements.

### Universally applicable

Its universal qualities are mainly due to its electro-mechanical construction, and partly due to its modular design. When the door drive motor operates, it simultaneously tensions a spring integrated in the drive housing. The shutting movement uses energy stored in the spring, which, depending on requirements, is also motor-assisted. Even without motor assistance, thanks to ingenious mechanics, optimum power deployment is achieved in the entire door swing area. This is necessary to move the door reliably to its end position against draft resistance, for example, and also complies with the norms and standards of current safety requirements.

The record DFA 127 is available to operate doors in sizes EN4 to EN6. The different spring forces required can be quickly and precisely adjusted on the spot using the special adjustment screw.

In detail, this model also provides many other sophisticated features, allowing pre-defined door types to be quickly and easily adapted to local and country-specific circumstances.

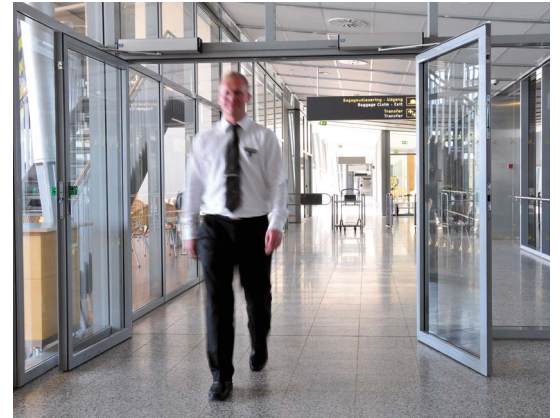

### Features:

- DIN 18 650-compliant technology, approved worldwide
- Approved as a hold-open system for fire protection barriers
- Can be used with various fire-protection profile systems such as Jansen, Forster, Heroal and Schüco
- Features gerontology technology for barrier-free access

### Variations:

- Double swing doors with or without master / slave operation
- Power saving mode: adjustable opening of one or both door panels (stretcher opening)
- Integrated sequential closing control for double-leaf fire door applications
- Interlock function for two single doors installed consecutively
- Direction-oriented opening for oncoming traffic in corridors
- Opening or closing without current

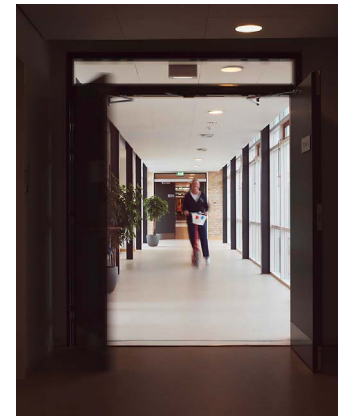

# DFA 127



**record**

your global partner for entrance solutions

# record DFA 127 – one drive system with four orientations

→ One version → modular construction → all types of installation → well-proven technology

## FULL POWER



## LOW ENERGY

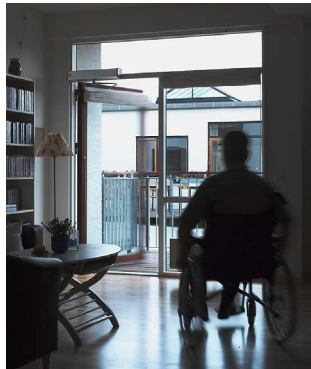

## INVERSE



## FIRE



**The STRONG one**  
very versatile

### Key benefits:

- Universal, powerful, programmable
- Extensive functionality without additional modules
- Robust, reliable mechanics

### Recommended use:

- Optimized for the use of large, heavy doors
- Provides a high level of dynamism



Compact and powerful

**The GENTLE one**  
with reduced motion energy

### Key benefits:

- Depending on location, little or no additional sensors required
- Lowers the inhibition threshold, even in elderly people
- Its gentle operation is convenient and inspires confidence

### Recommended use:

- Suitable for environments with people of limited or slow reactions



Can be used without security or safety sensors

**The SAFE one**  
opens without mains power

### Key benefits:

- No emergency power supply required
- Opens by spring force
- Door hinge is integrated into drive (no tripping hazard on the ground)

### Recommended use:

- Opens to vent smoke from inside buildings in case of fire
- Guides people in power failures



Opens in power failures, enhances safety and guidance in emergencies

**The RELIABLE one**  
closes reliably in case of fire

### Key benefits:

- Combines comfort with safety
- Can be used with various fire-protection profile systems

### Recommended use:

- Acts as a fire and smoke barrier



Secure closure in case of fire

## The following is valid for all drive types:

- Identical design of available models
- Technically unified, coherent approach
- Proven peripherals, developed and produced in-house
- Cross-platform operating system
- Remarkably smooth in operation
- Easy to maintain and reliable
- Drive housing available in stainless steel or aluminium
- Surface treatments available in a variety of designs and finishes



**Crew**



**DFA 127**



**record**

your global partner for entrance solutions

## record DFA 127 – the right choice every time

The FULL POWER and LOW ENERGY versions demonstrate that the DFA 127 is the correct choice despite conflicting requirements. The strength of the FULL POWER version can move doors of several hundred kilos in weight, whereas the LOW ENERGY version, however, is limited to 1.6 joules of kinetic energy to enable it to operate safely without special sensors.

### record DFA 127 FULL POWER

The record DFA 127 FULL POWER is the powerhouse in the family of record swing door operators. Its adjustable spring force gives it great versatility, and can be adjusted on the spot, enabling a range of door sizes from EN4 to EN6 to be used. This enhances its flexibility, enabling it to take additional customer-specific settings. Its sophisticated technology is under the auspices of the record control, enabling complex functions with optimum power deployment in the entire swing area.

#### Especially suitable for use in:

- Retail outlets
- Airports
- Administration and office buildings
- Restaurants and hotels

### record DFA 127 LOW ENERGY

The record DFA 127 LOW ENERGY is the ideal drive for environments where people move only slowly and have limited reaction capacity, such as hospitals and nursing homes. Kinetic energy is limited to 1.6 joules, which means the safety of people in the swing area, even in the absence of additional security sensors, is not compromised.

#### Especially suitable for use in:

- Homes for the elderly and disabled
- Hospitals, clinics and retirement homes
- Private homes and apartments

#### Special benefits:

- Thanks to its smooth, even movement, it lowers the inhibition threshold of slow-reacting people
- Additional security sensors can be dispensed with
- Practically silent operation preserves the peace and quiet of living areas

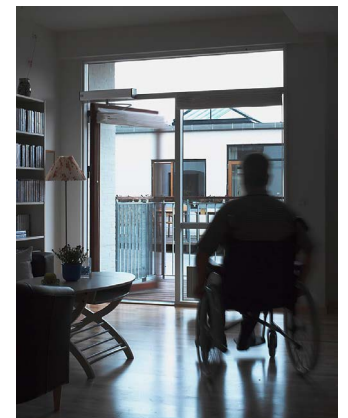



Ausgang Zentrum  
Ausgang Zahnklinik

DFA 127



**record**

your global partner for entrance solutions



## record DFA 127 – escape route and fire protection applications

For escape route and fire protection applications, record has the INVERSE and FIRE versions. These are further variations of the record DFA 127 electro-mechanical swing door operator, although look identical to them.

### record DFA 127 INVERSE

The record DFA 127 INVERSE enables doors to open securely and reliably, even without a power supply. During the motor-driven closing cycle, the energy required for opening is mechanically stored using a spring. Should smoke start to fill the building, the independent smoke and heat venting system controls the drive, and the INVERSE opens reliably, even during power failures. The door can therefore be used to allow fresh air to circulate inside buildings, or to vent smoke and heat.

#### Especially suitable for use in:

- Escape route openings
- Securing guide routes for persons
- Venting smoke and heat

#### Special benefits:

- The opening stop is integrated into the door drive system (no hazard for pedestrians to stumble over)
- No emergency power supply required to open the door
- The electromagnetic parking brake means additional electrical opening devices on interior doors can be dispensed with.



### record DFA 127 FIRE

The record DFA 127 FIRE is approved for use as a smoke and fire protection door. In case of fire, a signal from the smoke and heat detector or fire alarm system triggers immediate closing of the passage. Closing takes place by spring force. The SFR 127's mechanical sequential control also enables double leaf fire doors to be used.

#### Especially suitable for use as:

- Fire and smoke protection barriers

#### Special benefits:

- Compact design thanks to built-in fire protection components
- Door system can be connected to on-site fire control
- Own additional control to connect smoke and heat detector ports
- Can be used with various fire protection profile systems

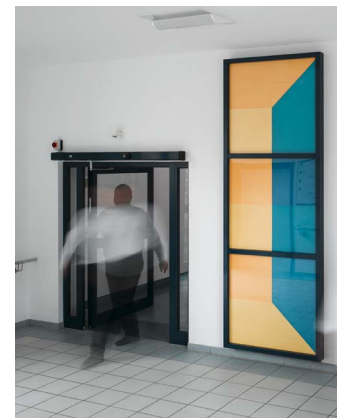



DFA 127



**record**

your global partner for entrance solutions

# record DFA 127 – technical specifications

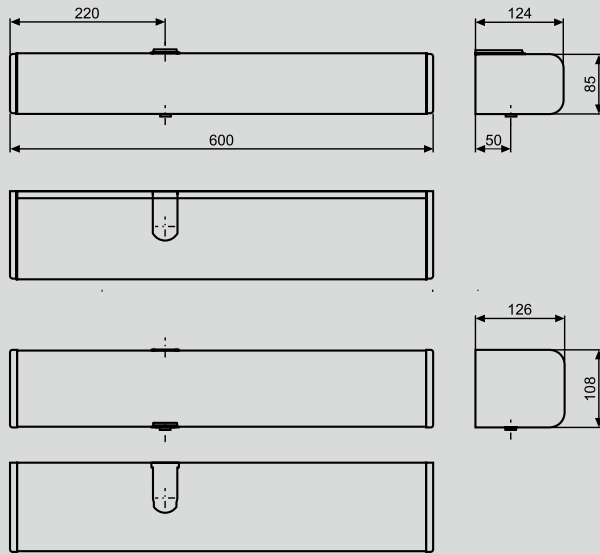

Dimensions of the operator (H x W x L)	85 x 124 x 600mm or 110 x 126 x 600mm
Door closer size	EN4 – EN 6 for standard arm and slide arm
Opening time / closing time	3 – 20s / 5 – 20s
Opening angle	70 – 115° (INVERSE up to 95°)
Electrical power supply	230VAC, 50 / 60 Hz
Rated power	67W
Consumption in standby mode	13W

Operating modes with internal BDI operating switch	Automatic operation
	Continuously open
	Manual operation

Operating modes with BDE-D control panel with display (optional)	Locked
	One-way traffic
	Operation lock

Functions	Automatic reverse
	Emergency stop, interlock control or 2-leaf doors
	Customer-specific door parameters

Options	Electro-magnetic brake
	Integrated mechanical sequential control SFR 127
	Special control option: «barrier-free WC access»
	Hold-open system for fire and smoke protection doors

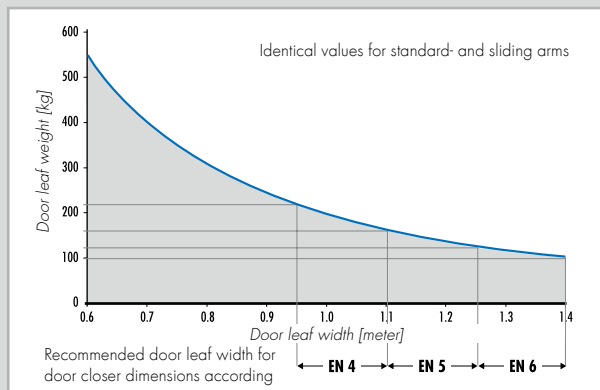

## Installation variants

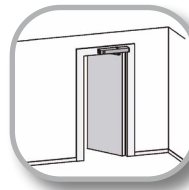

**Lintel installation**  
(1-leaf door)  
Standard bars, DIN left or right, pushing;  
drive variant for pushing sliding bars  
available

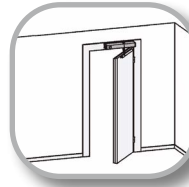

**Lintel installation**  
(1-leaf door)  
Slide arm DIN left or right pulling



**Lintel installation**  
(2-leaf door, master / slave operation)  
Two electrically coupled drives with  
standard arm pushing or slide arm  
pulling



**Lintel installation**  
(2-leaf door with two-way traffic)  
Alternating operation of two drives that  
are independent of each other



**Door leaf installation**  
(1-leaf door)  
Arm and possible combinations such as  
lintel installations

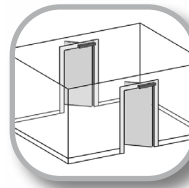

**Interlock operation**  
(2 x 1-leaf doors standing one after  
the other)  
Two electrically interconnected drives  
in all arm variants

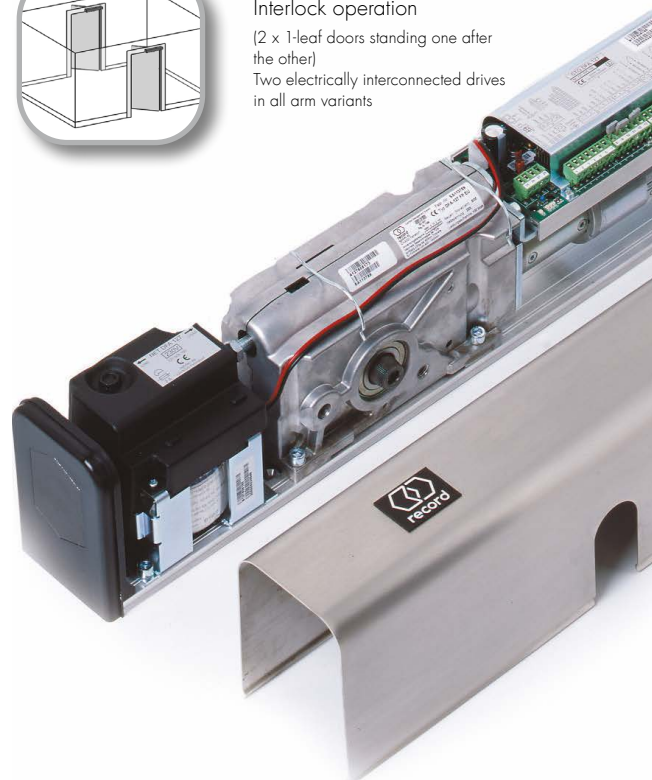

## Accessories and options

### Arm types

- The power transmission from the drive to the door works by means of a bar, which, depending on the mounting situation is available as a standard or sliding arm. Standard arms are available in different lengths to compensate for a range of lintel sizes.
- Through the use of optional axle extension pieces, so-called spacer bushes, different lintel heights can be compensated for.

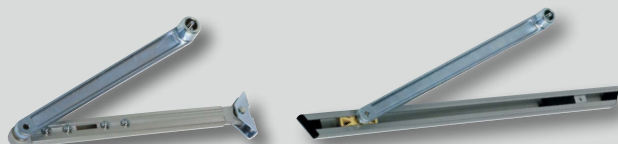

Standard arms, pushing

Sliding arms, pulling or pushing

### Lintel depths

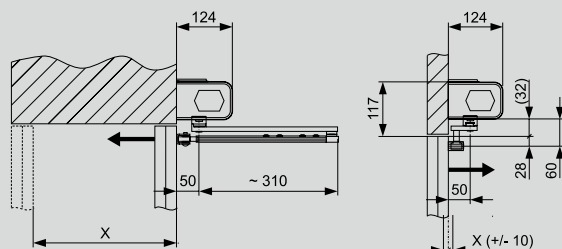

Type	Standard arm SG1 – SG3	Slide arm GG
Lintel depths	$X = 0 - 330\text{mm}$	$X = 0 + / - 10\text{mm}$

### Axis extensions

- For standard or slide arm



Type	Standard arm pushing	Slide arm pulling
20 – 80	42.5 – 102.5 mm	32.0 – 92.0 mm

### Sensor systems

- record RAD 290 radar motion detector
- Infrared presence detector
- Security sensors for the monitoring of the door swivel area



### Product range



FULL POWER    LOW ENERGY    INVERSE    FIRE

(conforms to DIN 18650)

### FULL POWER + LOW ENERGY + FIRE

- Currentless drive units function like a mechanical door closer

### INVERSE

- Currentless drive unit opens using spring tension

### Arm systems and accessories

- Standard arm: pushing, different lengths
- Slide arm pulling and pushing with integrated stop
- Axis extensions

### Operator casing

- Standard (stainless steel 85 mm) and in aluminium 85 mm or 108 mm
- Extended as required
- Extended for double swing doors (master / slave operators)

### Treated surfaces

- Satin stainless steel or coloured aluminium or anodised



### Spring tension

- Adjustable spring pretensioning (EN4 – EN6)

### Installation versions

- Lintel installation on hinge side or opposite hinge side
- Door panel assembly
- Hold-open systems for fire protection barriers
- Master / slave operation applied as fire proof doors require also a mechanical sequential control SFR 127



### Trigger devices



- Radar motion detector RAD 290
- Active and passive infrared sensors
- Hygienic sensor
- Push button

- Presence detector
- Pull switch
- Remote controller
- Key operated contact



### Smoke and fire detector

#### Main switch

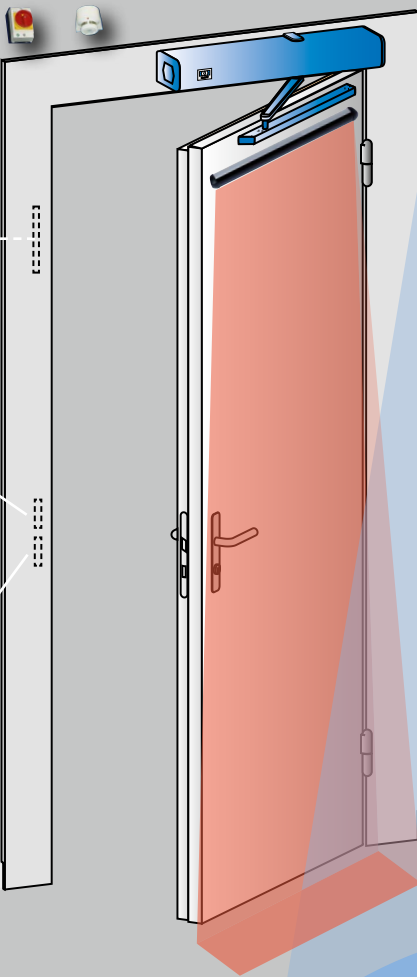

### Safety + security sensors (both sides)

- Sensor bar to monitor door swing area: flexible cable routing for existing doors



### Electrical lock and emergency switch

- To secure escape routes



### Electrical lock

- To open fire and smoke proof doors (approval necessary)

### Locking contacts

### Additional options

- Interlock control (master / master)
- Mechanical integrated sequential control, for use with fire protection doors (only possible with housings 108 mm high)

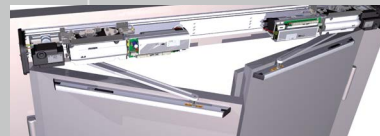

### Control panel

- BDI (toggle switch standard)
- Options:
  - BDE-D with display
  - Manual switch
  - BDE-M (mechanical key switch instead of BDI)



# DFA 127



# DFA 127



**record**

your global partner for entrance solutions

## record DFA 127 – Inspection and Maintenance Services

We have been manufacturing and marketing automatic door systems since 1953. The very first applications were to operate doors in laundries, but automatic door drives rapidly developed into attractive entrance systems with very different functional principles, initially driven by time-saving needs. Later came the prestige element, and today our door systems enhance the architecture of any building, actively contributing to its security and safety, and saving energy by reducing heating and air conditioning costs.

In the course of these developments, our products have become increasingly more refined, their functionality more comprehensive and their operation more convenient and user-friendly. At the same time, the legal requirements have become more demanding in order to enhance operational safety.

### The right service package for your needs

Today there are over 8 000 record automatic door systems installed all over Switzerland, our home market, still operating smoothly, even after 20 years or more! Our customers use them every day and this enhances their satisfaction. Reliability such as this is only possible with a combination of clear aims and goals, the highest standards of design, construction and installation, and long-term maintenance by record's highly skilled in-house service technicians.

For your automatic door to function smoothly over decades and be able to fulfil the relevant safety and security regulations, periodic servicing and maintenance is unavoidable. Benefit from the flexibility of a record maintenance contract, which will allow you to vastly reduce your operational and maintenance costs.

### Your nearest record partner

Inspection and maintenance have a particularly high priority at record. The fact that record products are designed and built to last a long time also means they face changing legal requirements. To avoid unpleasant situations for our customers, we make it our priority to personalise our service and maintenance packages, enabling you to fully meet your legal requirements of due diligence.

In consultation with you, our advisor will find the ideal maintenance and service package to meet all your needs.

To know more, please get in touch with your record partner!



## Contact

→ **record UK limited**

Head Office: Unit D, 9 Watt Place – Hamilton International Park – Blantyre – G72 0AH – UK  
Central Office: 450a Bradford Road – Batley, WF17 5LW – UK  
Southern Office: 17 Invincible Road – Farnborough, GU14 7QU – UK  
tel.: +44 1698 376411 – fax: +44 1698 376422 – [info@recorduk.co.uk](mailto:info@recorduk.co.uk) – [www.recorduk.co.uk](http://www.recorduk.co.uk)

→ **record global export**

agtatec ag – Allmendstrasse 24 – 8320 Fehrltorf – Switzerland  
tel.: +41 44 954 91 91 – e-mail: [international@agta-record.com](mailto:international@agta-record.com) – [www.agta-record.com](http://www.agta-record.com)

→ **Headquarters**

agta record ltd – Allmendstrasse 24 – 8320 Fehrltorf – Switzerland  
tel.: +41 44 954 91 91 – e-mail: [info@agta-record.com](mailto:info@agta-record.com) – [www.agta-record.com](http://www.agta-record.com)

