

Entrance Control

Solutions

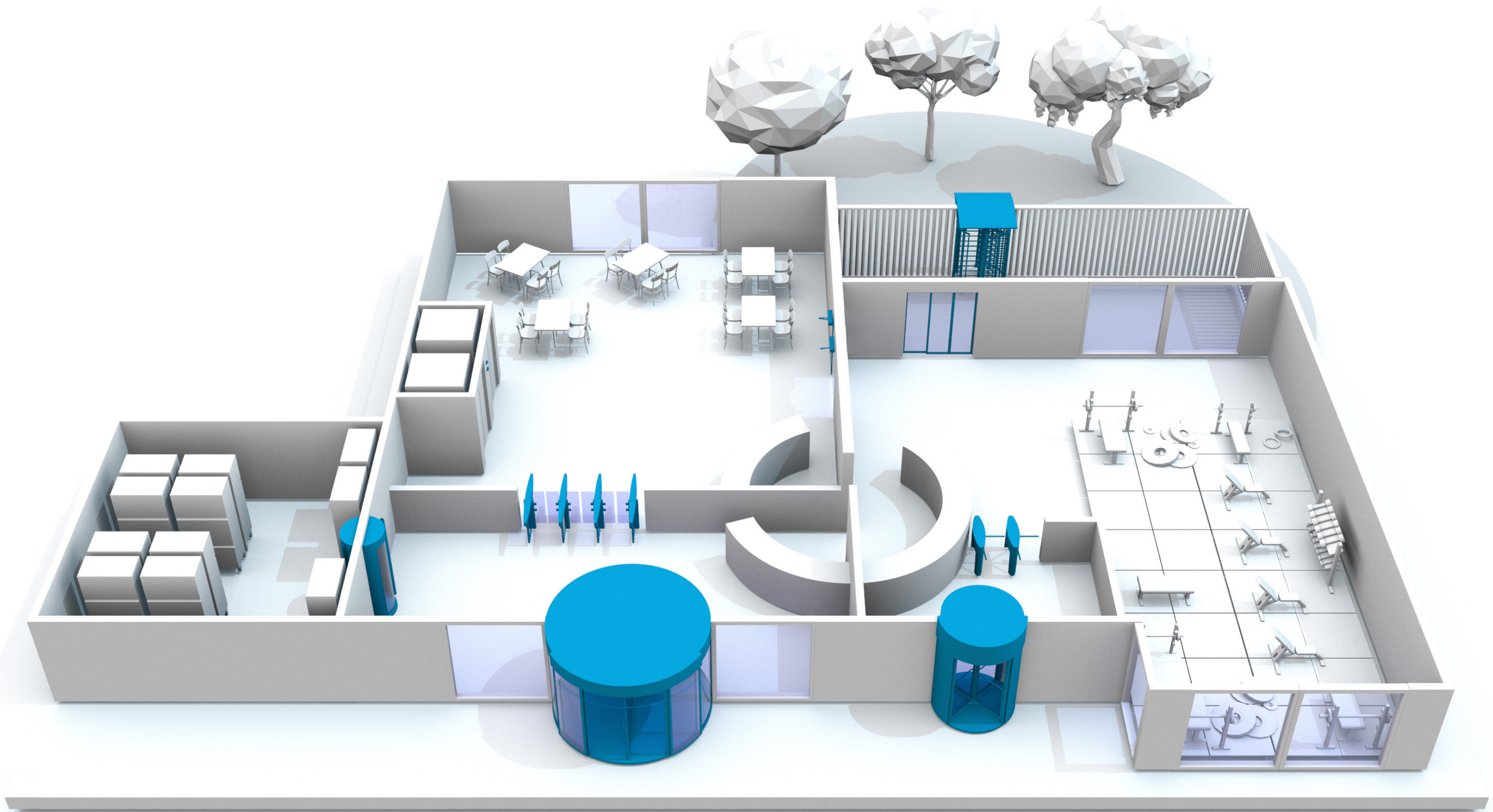



Inspiring designs
crafted with **passion.**

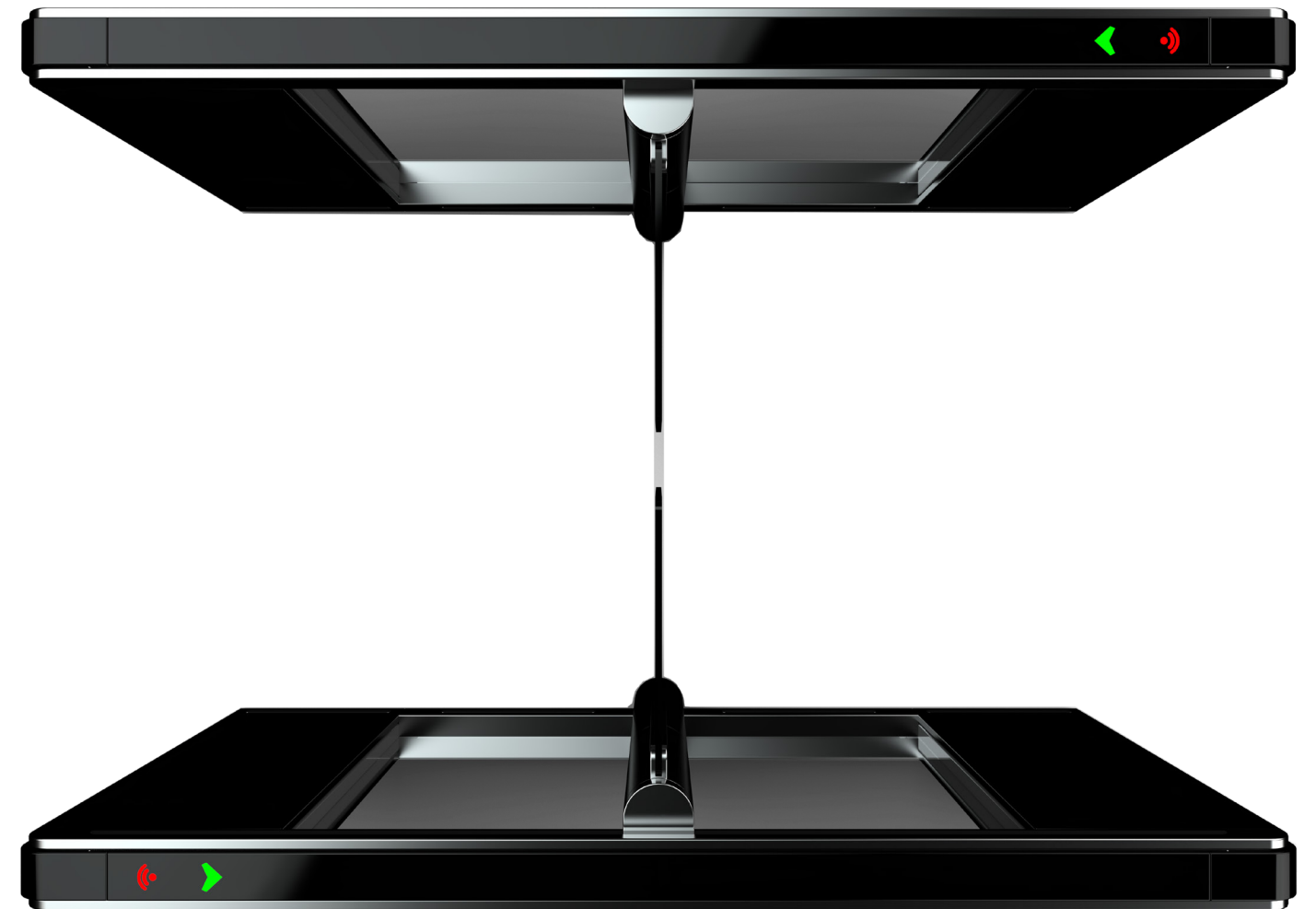

Vision Touch

Speed Gate Turnstiles

A compact design that fits in any environment. It poses a modern aesthetic with great value.



Vision Edge

Slim Speed Gate Turnstiles

The Vision Edge is a slim design that provides maximum safety and a high human flow rate at the same time.

For the correct walking route, light guide pictograms give clear instructions to staff and visitors.

Adjustable door direction control adds flexibility to building access control systems and improves people flow for efficiency and user convenience.



Loop LS 140

Obstruction free Speed Gate Turnstile

Loop LS 140 series is suitable for environments that must have a continued opening without any obstruction.



Compact CA 100-105

Retractable Speed Gate Turnstile

A classic hidden speed gate with 24V DC motor. Opening and closing time between 0.5 - 1.0 sec.



Tripod Turnstiles

Robust turnstiles for heavy traffic use with stainless steel arms. Bi-directional, logic controlled, LED indicators included on both entrance and exit sides. Hand-operated; hand operated with drop arm; motor driven with drop arm options available. All Tri-pods uses the same electro-mechanic drive and or motorized drives.

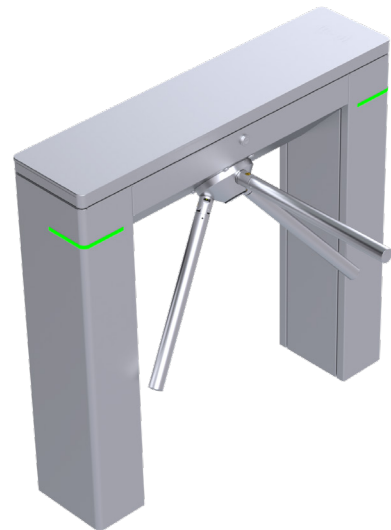

Passage width:

530 mm
Arm length:
480 mm
Cabinet size (W x L x h):
250 x 1050 x 1000 mm

Lid material:

2.0 mm stainless steel
Cabinet material:
- 2.0 mm AISI 304 stainless steel
- 2.0 mm AISI 316 stainless steel

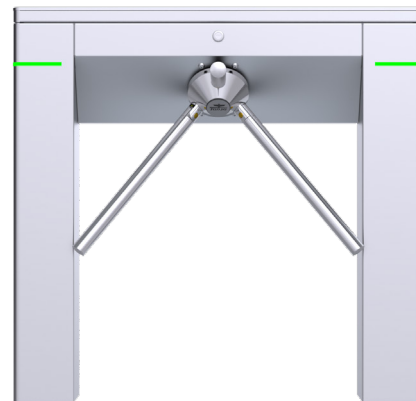

Passage width:

560 mm
Arm length:
510 mm
Cabinet size (W x L x h):
250 x 1200 x 1000 mm

Lid material:

2.0 mm stainless steel
Cabinet material:
- 2.0 mm AISI 304 stainless steel
- 2.0 mm AISI 316 stainless steel

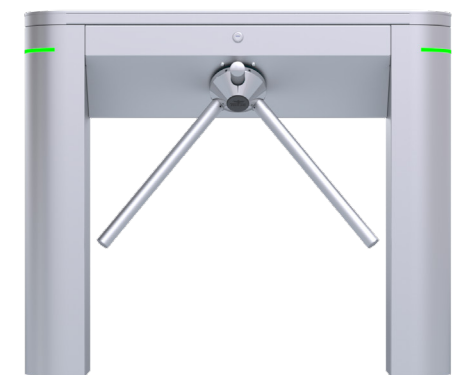

Passage width:

530 mm
Arm length:
480 mm
Cabinet size (W x L x h):
250 x 1050 x 1000 mm

Lid material:

10 mm tempered glass
Cabinet material:
- 2.0 mm AISI 304 stainless steel
- 2.0 mm AISI 316 stainless steel

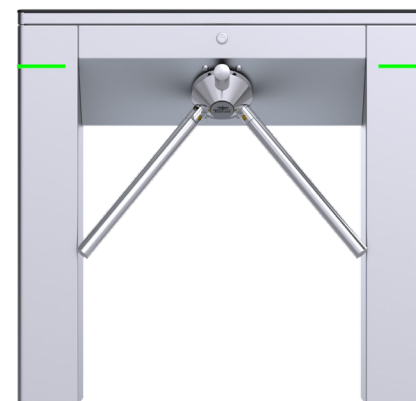

Passage width:

560 mm
Arm length:
510 mm
Cabinet size (W x L x h):
250 x 1200 x 1000 mm

Lid material:

10 mm tempered glass
Cabinet material:
- 2.0 mm AISI 304 stainless steel
- 2.0 mm AISI 316 stainless steel



Tripod Turnstiles

Pass Gate

SGR100



SGW175





Maxima Full Height Turnstile

Extremely robust and water resistant, 3 or 4 section full height turnstiles in stainless steel; hot-dipped galvanized or galvanized plus powder coated finish. Bi-directional, logic controlled, hand operated and motor driven with electro-magnetic lock options available.

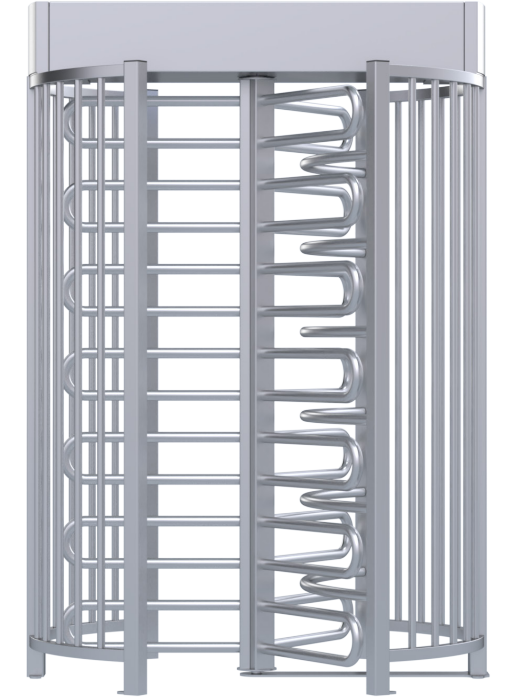
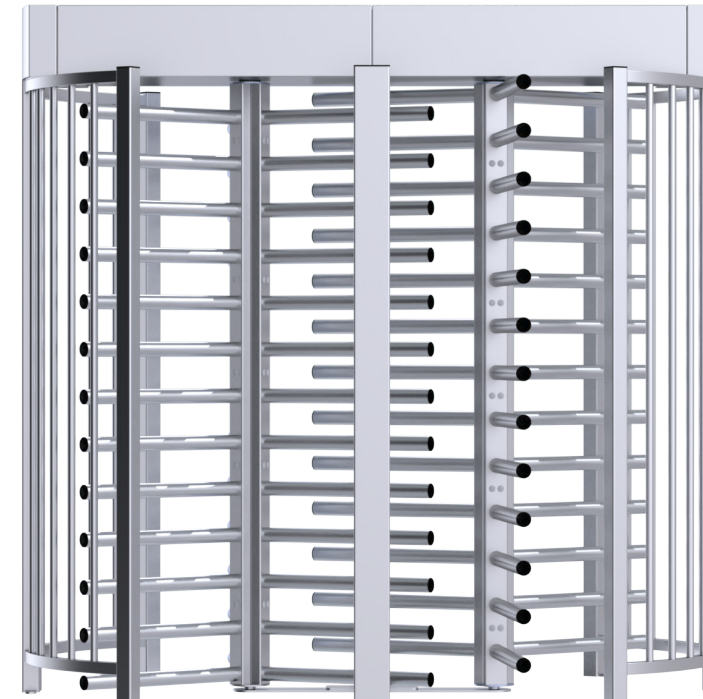
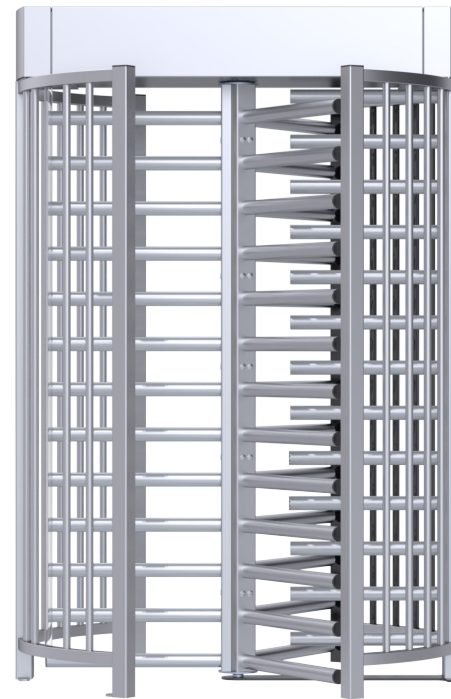
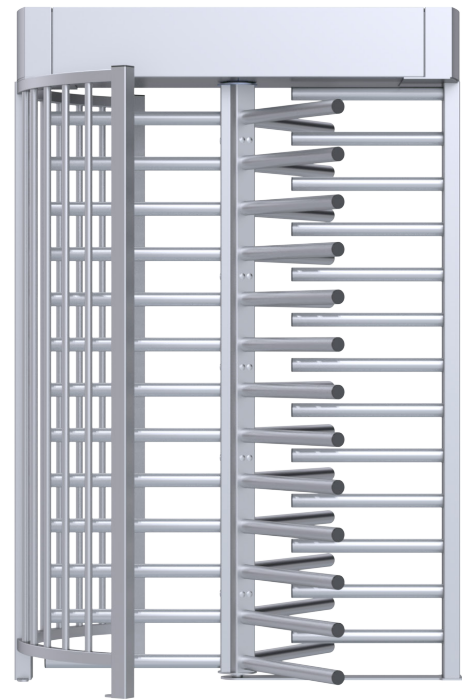

Passage Height: 2125 mm / **Complete Height:** 2370 mm / **Complete Height for Motor Driven:** 2460 mm

Model	Passage Width	Length & Width
RT 170 Rotor 120 °	670 mm	1580 x 1372 mm
RT 170 Rotor 120 °	630 mm	1501 x 1295 mm
RT 170 Rotor 120 °	600 mm	1441 x 1207 mm

Model	Passage Width	Length & Width
RT 171 Rotor 120 °	670 mm	1580 x 1372 mm
RT 171 Rotor 120 °	630 mm	1501 x 1369 mm
RT 171 Rotor 120 °	600 mm	1441 x 1206 mm

Passage Height: 2125 mm / **Complete Height:** 2370 mm / **Complete Height for Motor Driven:** 2460 mm

Model	Passage Width	Length & Width
RT 272 Rotor 120 °	670 mm	2428 x 1372 mm
RT 272 Rotor 120 °	630 mm	2348 x 1372 mm
RT 272 Rotor 120 °	600 mm	2288 x 1372 mm

Model	Passage Width	Length & Width
RT 363 Rotor 120 °	670 mm	1580 x 1372 mm
RT 363 Rotor 120 °	630 mm	1501 x 1369 mm
RT 363 Rotor 120 °	600 mm	1441 x 1206 mm

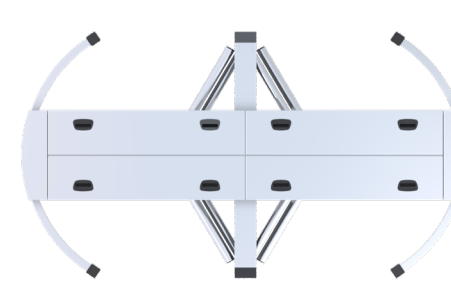
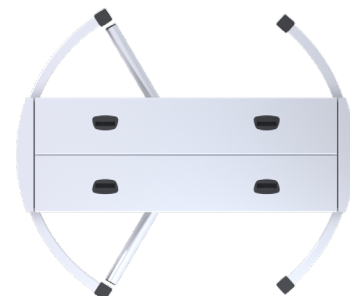
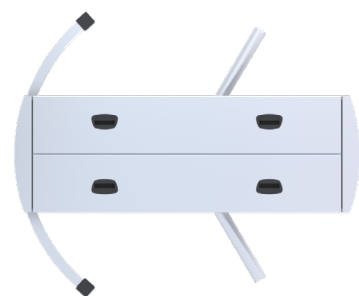

Maxima Full Height Turnstile

The extremely robust and water-repellent turnstile with bicycle door for controlled access.

This turnstile combines controlled access for people with a separate passage for bicycles. Depending on the access control system, e.g. card reader or hand switch, the turnstile enables passage to the site. When the built-in induction loop detects a bicycle at the same time, the passageway automatically opens for the bicycle and the person can pass through the entrance with their bicycle. The bicycle door closes again after a set time.

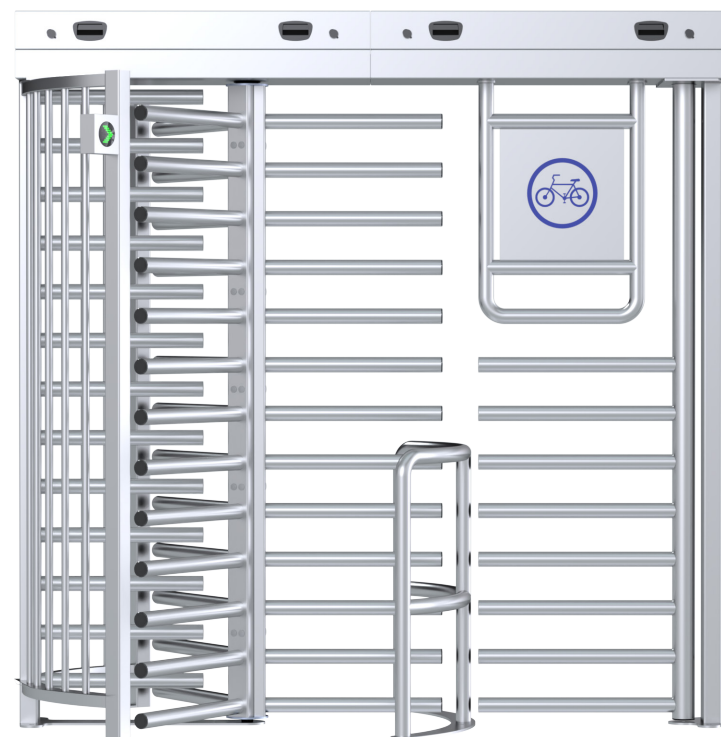





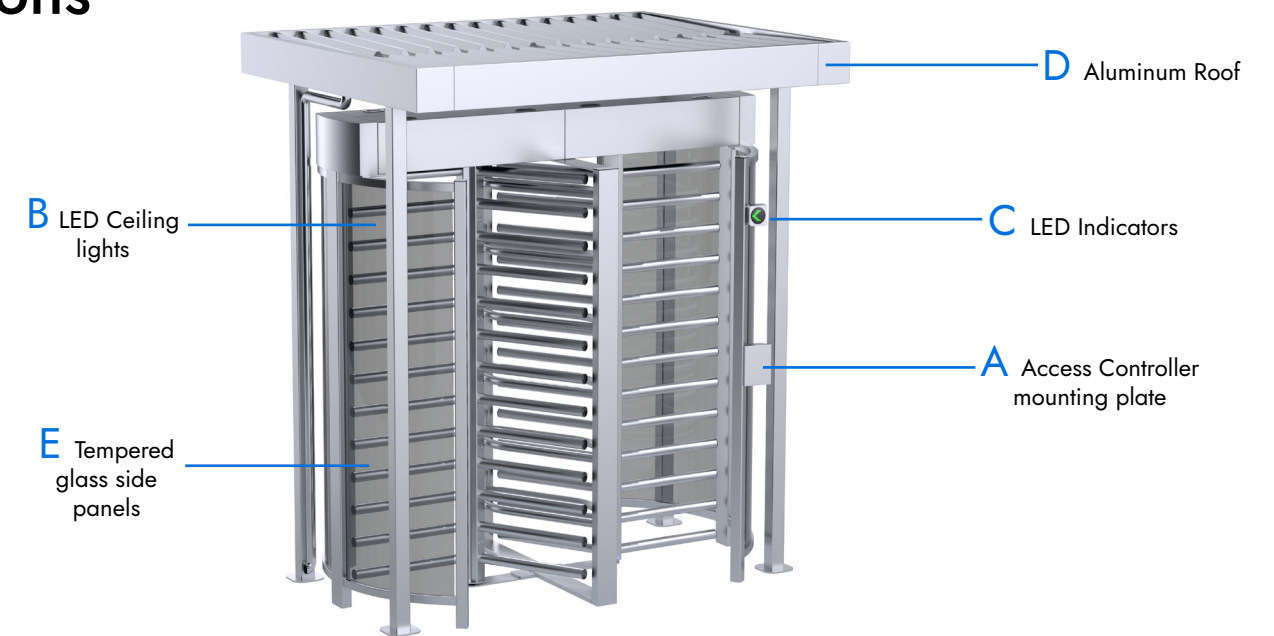

Passage Height: 2125 mm / **Complete Height:** 2370 mm / **Complete Height for Motor Driven:** 2460 mm

Model	Passage Width	Length & Width
RT 430	630 mm	2330 x 1369 mm

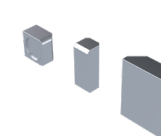
Options

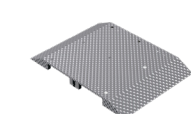
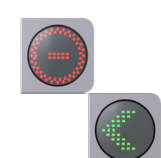
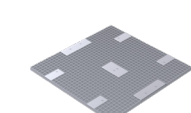

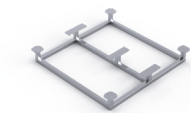
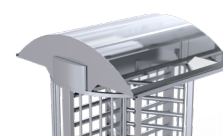
A-1	 Access Controller mounting plate	E	 Tempered glass side panels
A-2	 Access Controller Box 100 x 100 mm with 60 mm depth 60 x 160 mm with 60 mm depth 150 x 200 mm with 60 mm depth		 Extreme weather heater for - 40°
B	 LED Ceiling lights		 Mounting plate (suitable for forklift transport)
C	 LED Indicators		 Mounting base plate with grid.
D-1	 Aluminum Roof		 Mounting frame for pre-installation into concrete
D-2	 Polycarbonate Canopy		

Maxima Full Height Pass Gate

Manual Swing Door

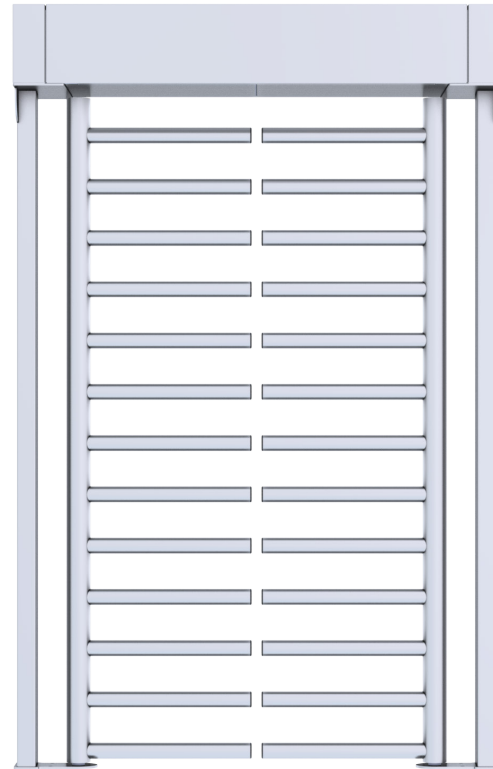
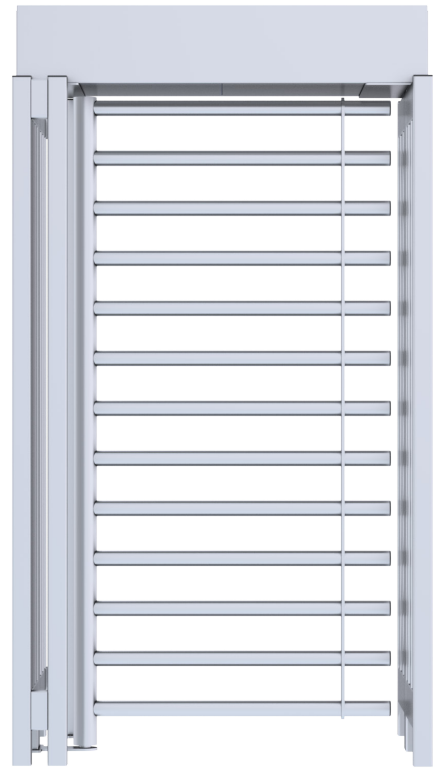

Passage Height: 2125 mm / Complete Height: 2370

Passage Height: 2125 mm / Complete Height: 2370 mm

Model	Passage Width	Length & Width
RT 501	1000 mm	1000 x 1300 mm

Model	Passage Width	Length & Width
RT 501	1044 mm	1500 x 500 mm

Model	Passage Width	Length & Width
RT 501	1869 mm	2341 x 900 mm

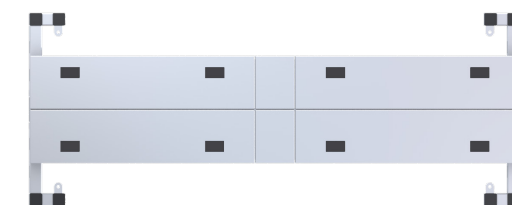
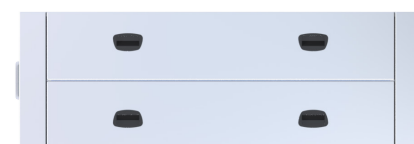
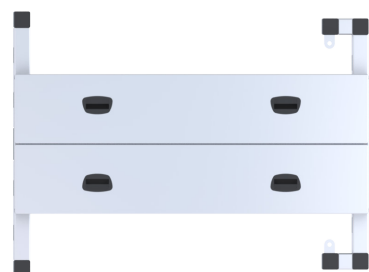

Maxima Full Height Pass Gate

Manual Swing Door

Full height manual operated security gates can be installed and operated individually or in conjunction with full height turnstiles. Right or left-hand swing directions can be selected.



Passage Height: 2125 mm / Complete Height: 2210 mm

Model	Passage Width	Length & Width
RT 000	1000 mm	2370 x 1053 mm
RT 000	1200 mm	2370 x 1253 mm
RT 000	1400 mm	2370 x 1433 mm



Record Direct
Unit 1, Maxted Park
Maxted Road
Hemel Hempstead
HP2 7EP
recordukdirect.co.uk